



University of Zagreb
Faculty of Civil Engineering

Marija Jelčić Rukavina, Milan Carević, Ivana Banjad Pečur

FIRE PROTECTION OF FAÇADES

The Guidelines for Designers, Architects, Engineers
and Fire Experts

| | |
|---------------------------|---|
| AUTHORS: | Marija Jelčić Rukavina, assistant professor, PhD. in civil engineering Milan Carević, senior lecturer, MSc. in architecture Ivana Banjad Pečur, full professor, PhD. in civil engineering |
| REVIEWERS: | Dubravka Bjegović, professor emerita, PhD. in civil engineering Zoran Veršić, assistant professor. PhD. in architecture |
| ILLUSTRATIONS: | Monika Jezidžić, MSc. in civil engineering David Božajić, BSc. in civil engineering |
| LANGUAGE EDITING: | Amalija Milovac, BSc. in Croatian language |
| DESIGN AND LAYOUT: | Zvonimir Mandić, designer |
| PUBLISHED BY: | University of Zagreb, Faculty of Civil Engineering Zagreb, Croatia |

ISBN: 978-953-8168-14-7
e-ISBN: 978-953-8168-15-4

The CIP record is available in the computer catalog of the National and University Library in Zagreb, under the number 000965602.

THE GUIDELINES WERE CREATED IN COOPERATION WITH:



CONTENT

| | | |
|-----|---|----|
| 1 | FOREWORD | 4 |
| 2 | GLOSSARY OF TERMS | 5 |
| 3 | ENERGY EFFICIENCY AND FIRE PROTECTION IN FAÇADES | 8 |
| 4 | MECHANISMS OF FIRE SPREAD ACROSS FAÇADES | 12 |
| 4.1 | Overview of larger fires of which spread is related to the type of façade | 16 |
| 5 | CROATIAN REGULATIONS REGARDING FIRE PROTECTION IN BUILDINGS | 19 |
| 5.1 | Fire Protection Act (Official Gazette 92/10) – overview of the most important paragraphs relevant to the Guidelines | 19 |
| 5.2 | Ordinance on Fire Resistance and other Requirements for Buildings in Case of Fire (Official Gazette 29/13, 87/15) | 20 |
| 5.3 | Detailed overview of Ordinance articles on the requirements regarding façade execution | 28 |
| 6 | DESIGN SOLUTIONS FOR COMBUSTIBLE CONTACT AND VENTILATED FAÇADES | 39 |
| 6.1 | Contact façade systems (ETICS systems) | 39 |
| 6.2 | Examples of fire barriers positioning in a building that belongs to subgroup ZPS 5 | 45 |
| 6.3 | Ventilated façades | 50 |
| 7 | PROBLEMS NOT COVERED BY THE ORDINANCE AND RECOMMENDATIONS FOR THEIR SOLUTIONS | 51 |
| 7.1 | Energy renovation of old buildings lacking a fire protection report | 51 |
| 7.2 | Ventilated façades | 51 |
| 7.3 | Execution of fire barriers in buildings that belong to subgroups ZPS1-ZPS3 i ZPS5 | 51 |
| 7.4 | Non-combustible bands at joints between buildings with different height | 51 |
| 7.5 | Cladding of firewall endings | 52 |
| 7.6 | Splashing zones, wet zones on façades | 52 |
| 7.7 | Passages, soffits and prominent parts of buildings | 53 |
| 7.8 | External evacuation stairs | 54 |
| 7.9 | Request for an unambiguous definition of design level elaborating the details of façade fire protection | 55 |
| 8 | QUOTED LEGISLATION AND LITERATURE | 56 |
| | ANNEX 1: Classification of construction materials according to reaction to fire properties | 58 |
| | ANNEX 2: Large scale testing of façade behaviour in fire | 62 |

1 FOREWORD

The obligation of EU countries to increase energy efficiency has brought changes to the second essential requirement in building construction, i.e. safety in case of fire. Required thicker layers of thermal insulation imply higher fire loads in buildings. In case of fire, usage of combustible insulation materials increases the risk of fire spread to adjacent buildings and higher floors and has a negative impact on the environment caused by a large quantity of emitted smoke.

Having this in mind, most EU countries have introduced regulations which define the ways of preventing possible fire spread across the façades of buildings with combustible thermal insulation. The regulations require either the design of layers of non-combustible materials, or the use of non-combustible insulation on high-rise buildings and buildings with high fire risk, such as buildings with a large number of users with reduced mobility capabilities, e.g. hospitals, nursery schools, retirement homes or other gathering places for a large number of people, such as concert halls, disco clubs etc.

Similar regulations have been introduced in Croatia and they have been defined by the *Ordinance on Fire Resistance and other Requirements for Buildings in Case of Fire* (Official Gazette 29/2013, 87/2015). The regulations thereof are complex, and the requirements related to the design and positioning of non-combustible layers on façades are inadequately described, with few graphic representations common in technical field. Additionally, there is a debate among designers, but also among competent inspection bodies issuing approval (certificate) for main projects, whether the layers should be described in main or executive designs. Furthermore, designers and contractors lack the experience in this type of façade construction. For these reasons there are different, contradictory interpretations or, ultimately, avoidance of regulations on fire barriers. That is why the main part of this Guidelines gives clear definitions of requirements, set out by legislation and by technical practice, describing the positions and details of construction of façade parts which have to be designed from non-combustible insulation materials.

In addition to reviewing the existing regulations, these Guidelines recommend their improvements, with the aim to protect human life and increase the safety of users of buildings, reduce the property damage and preserve the environment.

Who are these Guidelines for?

- Participants in the process of energy renovation of buildings,
- Investors, designers and constructors,
- Fire safety experts,
- Fire safety inspectors,
- Members of associations (HUZOP – Croatian Association for Fire Protection, HUPFAS (Croatian Association of Thermal Façade Systems Producers), HSZG (Green Building Council Croatia), HKA (Croatian Chamber of Architects), HKIG (Croatian Chamber of Civil Engineers) and HUEC (Croatian Association of Energy Certificates),
- Architecture and civil engineering students,
- Students of construction vocational schools,
- Various programs for lifelong learning, among others through CROSKILLS projects

We would like to thank the Ministry of Interior Affairs and the Ministry of Construction and Physical Planning for their helpful suggestions.

Authors

2 GLOSSARY OF TERMS

This paragraph defines the terms used in these Guidelines. The terms from current legislation have been taken in their original form, and other terms have been proposed by the authors.

- | **Façade** is a system of construction products applied on the external wall of a building (load bearing or not), which simultaneously secures the prescribed properties of building physics (protection from weather conditions, thermal insulation) and fire protection.
- | **ETICS System (contact façade)** is a system produced at construction sites from prefabricated elements. It is delivered as a complete system, and Figure 1 states the minimum custom-made components it contains. Other names for ETICS system are: a connected system for external thermal insulation, a contact façade or a contact façade system.



1. Adhesive mortar,
2. Thermal insulation material,
3. Mechanical fixings (screw dowel),
4. Mortar for reinforcement layer,
5. Glass fibre mesh,
6. Finishing layer with pre-coat and/or decorative plaster

Figure 1. Components of ETICS façade system

- | **Ventilated façade** is a façade system with a ventilating layer between the thermal insulation and the claddings connected with the external air through openings which enables a continuous air current. It consists of the components shown in Figure 2.

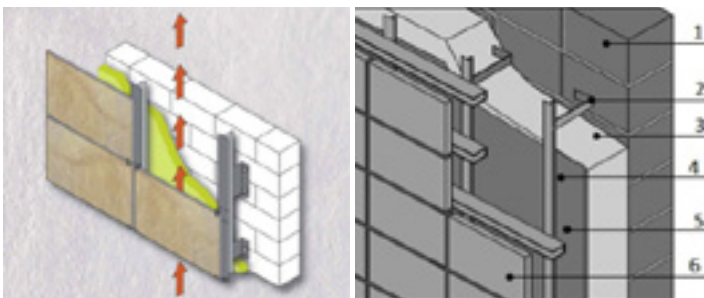

Figure 2. Components of a ventilated façade system

- | **Classified façade system** is a system which, as a whole with all its components, has been tested and evaluated by procedures set by standards regarding its reaction to fire properties.

- | **External wall** is a single layer or multilayer, load bearing or non-bearing wall structure that divides the space inside the building from the external environment.

- | **Euroclass system** is a classification system for building products based on their reaction to fire performance in accordance to standard HRN EN 13501-1:2010.

- | **Reaction to fire** is response of a materials/products in contributing by its own decomposition to a fire to which it is exposed, under specified conditions.

- | **Fire resistance** is ability of a structure, a part of a structure or a member to fulfill its required functions (load bearing function and/or fire separating function) for a specified load level, for a specified fire exposure and for a specified period of time.

- | **Flashover** is transition to a state of total surface involvement in a fire of combustible materials with an enclosure.

- | **Firewall** a separating element, a wall separating two spaces (e.g. two buildings) and designed for fire resistance and structural stability, and may include resistance to horizontal loading so that, in case of fire and failure of the structure on one side of the wall, fire spread beyond the wall is avoided.

- | **Fire compartment** is a space within a building, extending over one or several floors, which is enclosed by separating elements so that fire spread beyond the compartment is prevented during the relevant fire exposure.

- | **Business units** are specific purpose areas that include working and auxiliary facilities with the total area of maximum permitted surface of fire compartment for that purpose.

- | **Industrial or manufacturing facility** is a building or a part of a building where manufacture, stacking components, preparation of products for distribution and the like take place, and it can have a supporting warehouse for products or goods used for manufacture, supporting administrative and auxiliary space which is in function of the stated purpose.

- | **Height of a building** is level of the surface of the highest point of the floor of the highest storey (excluding any such storey consisting exclusively of plant rooms) measured from the level of the surface of the lowest fire service access roadway adjacent to the entrance to the fire-fighting shaft where the measurement is greatest.

- | **Gross floor area** is the floor area together with the floor surface of the walls including cladding, wall lining etc. The gross floor area of apartments and business units connected by a partition wall is calculated up to the axis of that wall.

- | **Non-combustible material** is a substance that cannot be ignited, does not burn, does not support burning or emit combustible gases when exposed to fire or heat in extreme use and under specific conditions. According to HRN EN 13501-1 :2010, non-combustible construction materials are reaction to fire materials class A1 and A2.
- | **Combustible material** is a substance that can be ignited, can burn, supports burning and can emit combustible gases. According to HRN EN 13501-1:2010 combustible materials are classified according to reaction to fire classes into B, C, D, E and F.
- | **Additional material classes** cover the classification of materials regarding the production of smoke in case of fire and they are as follows:

s1 (very limited production of smoke – little smoke),

s2 (the entire production of smoke and the growth of smoke quantity are limited – medium quantity of smoke),

s3 (no limit to the production of smoke – a lot of smoke).

Other criteria for additional classification is related to occurrence of flaming droplets/particles in case of fire and they are as follows:

d0 (limited production of flaming droplets/ particles),

d1 (time-limited production of flaming droplets/particles),

d2 (producing flaming droplets/particles without time limit).

- | **Fire load** is a sum of thermal energies which are released by combustion of all combustible materials in a space (building contents and construction elements).
- | **Fire load density** is fire load per unit area related to the floor area q_p , or related to the surface area of the total enclosure, including openings, q_s .
- | **Fire protection report** presents a set of data (requirements and / or limitations) on systematic fire protection for the building, consisting of a textual part and drawings with details.

3 ENERGY EFFICIENCY AND FAÇADE FIRE PROTECTION

The energy efficiency is today in Europe one of the main priorities because it is the basis for the sustainable development of Europe, it contributes to energy security and independence and, not least important, affects the reduction of greenhouse gas emissions. The European Commission has emphasised this fact in its strategic documents, of which the most important are the following:

- Green Book – European strategy for sustainable, competitive and safe energy [1]
- Action plan for energy efficiency [2]
- 2030 Climate and energy framework [3]
- Plan for energy efficiency [4], [5]

The measures for energy efficiency in buildings are increasingly being recognized as the instrument for achieving a sustainable energy supply, a reduction of greenhouse gas emission, improvement in reliable supply and reduction of transport costs, but also in the promotion of competitiveness of European economies. The European Union has created two key documents that define the framework for the area of energy consumption in buildings, and they are the Energy Efficiency Directive (EED) and the Energy Performance of Buildings Directive (EPBD). All EU member states, including Croatia, have recognized the the buildings as an area with the biggest potential to reach the set goals (Figure 3) which European Commission adopted in October 2014 [3]:

- 40% lower emission of greenhouse gases compared to 1990;
- 27% share of renewable energy resources in total energy consumption;
- 27% (30%) lower energy consumption in buildings.

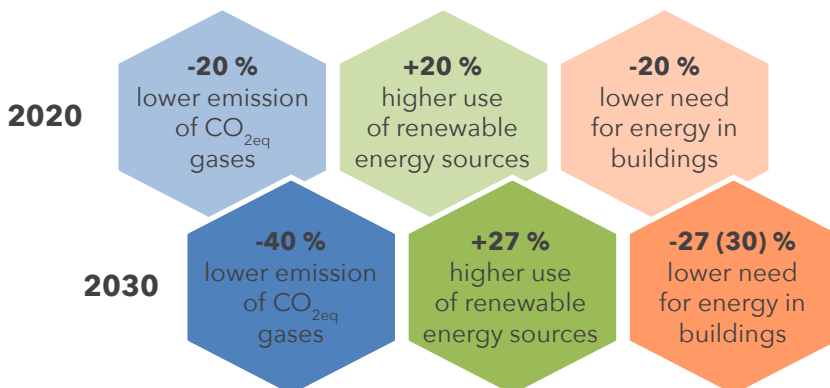

Figure 3. Comparison 2020 and 2030 goals [8]

The signing of the Paris Agreement at the Conference of Parties in Paris (COP21) held in December 2015 [6] proves how serious the intentions of European policies are with regards to greenhouse gases (which include energy efficiency in building construction). Conference COP22, held in Marrakech in November 2016, confirmed the implementation of the Paris Agreement.

EU has also set long-term 2030, respectively 2050 energy goals [7,8]. Given the fact that the data show that EU buildings consume 24,8% of energy (Figure 4), and that this sector might grow, the goal of reducing energy consumption and to use renewable energy resources in buildings is one of the most important measures undertaken with a view of reducing the import and energy dependence of the Union as well as reducing greenhouse gases emission.

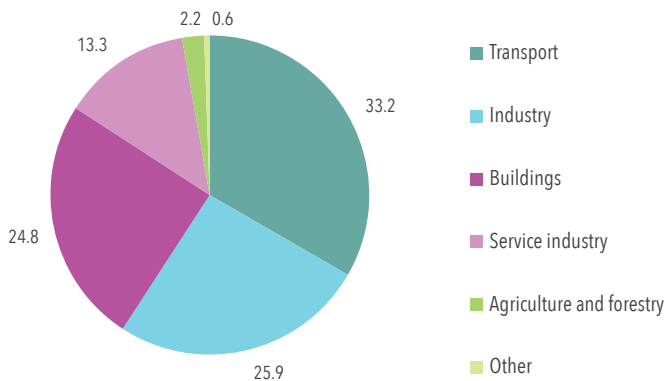

Figure 4. Energy consumption by sectors in %, EU -28, 2014 [9]

Having joined EU, Croatia has accepted the entire *acquis*, including all the obligations and regulations on energy efficiency in building. Current plans on energy renovation of buildings in the Republic of Croatia are aimed at gradual and systematic energy renovation of the existing buildings. The main assessment criteria are the reduced CO_{2eq} emission and the reduced consumption of energy used for heating, cooling, air-conditioning, ventilation and water heating in buildings.

The requirements for the increased energy efficiency in buildings influence fire properties of buildings. With the goal of reducing energy consumption, the regulations are constantly getting stricter on thermal properties of construction elements used in façades. Since the thickness of the insulation layer has been at least doubled, compared to former requirements (Figure 5), with a tendency of further increase (with the aim to reach the goals in 2020), total fire loads have been increased, especially if combustible thermal insulation is installed on a façade. Consequently, the duration of fire and its extinguishing is extended, which ultimately increases the risk of fire spread across façades, and its further spread into the interior of buildings, respectively, onto surrounding buildings.

Additionally, special attention should be paid to fire protection measures during construction work (the construction of a building or the energy renovation of a building), because the storage and installation of combustible insulation increases the risk of fire occurrence and its spread since it is not protected by all layers in the system (e.g. ETICS).

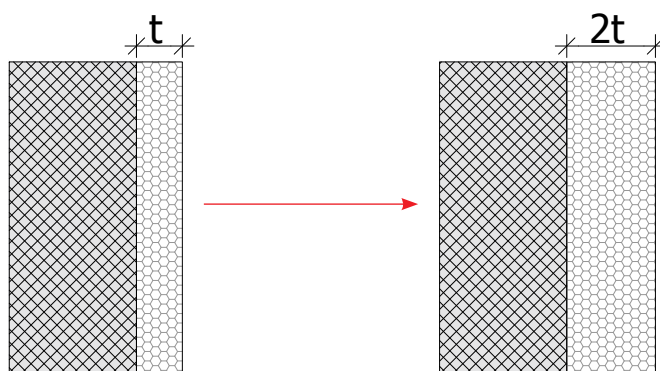

Figure 5. The increased thickness of thermal insulation layer as a result of energy efficiency in buildings

The materials that can be used as a thermal insulation layer in façade systems are shown in Table 1.

Table 1. Products for thermal insulation [10]

| Generic description | Examples | Applications |
|---|--|--|
| Non-combustible materials and materials with limited combustibility | Mainly products made from mineral fibres like stone and glass wool, to which a resin-based binder is added. | Manufactured in sheets and rolls of different sizes. |
| Thermostable products | Polyurethane (PUR) foam, polyisocyanurate (PIR) foam or phenolic foams. | Manufactured in sheets of different sizes and thickness depending on required thermal properties. Often installed facing with materials like glass fibres or aluminium foil. |
| Thermoplastic products | Well-known products in this category are expanded (EPS) and extruded (XPS) polystyrene. It can be supplied in both fire-retarded and non-fire-retarded forms. | Material is usually delivered in thin sheets of different sizes and thickness depending on the required thermal properties. |
| Natural fibres | Wood fibres, cork, sheep wool, cellulose and hemp are increasingly being used. They are manufactured by soaking, heating and compression with the aim of making a flat product. Sometimes various binders are used to achieve required properties. | Materials are usually delivered in thin sheets of different sizes and thickness depending on the required thermal properties. |
| Recycled materials | Various materials can be used as insulation materials, like recycled paper and newsprint, shredded rubber and combinations of other materials which can be treated or used with binders to achieve required properties. | Available in various forms, most often in the form of compressed boards. |

In the Republic of Croatia, the most often used materials for thermal insulation layers as part of ETICS systems are expanded polystyrene (EPS), which complies with the standard HRN EN 13163:2016, and mineral (stone) wool which complies with the standard HRN EN 13162:2015. Other materials listed in Table 1 are not covered by valid technical regulations.

Fire load density (MJ/m^2) of thermal insulation materials installed into façades considerably differ, depending on the material. The total specific fire load of the materials commonly used in contact systems (ETICS) of façades is 7.3 times higher for EPS, 4.35 times higher for PIR, respectively 4.5 times higher for PUR compared to mineral (stone) wool for the same rate of heat transfer resistance required for energy efficiency of a building, which is shown in Figure 6. It should be noted that with the stricter regulations on energy consumption in buildings, with the aim of fulfilling the goals by 2030 and 2050, the façade fire load will increase, due to the increased thickness of thermal insulation materials.

Fire load density [MJ/m^2]

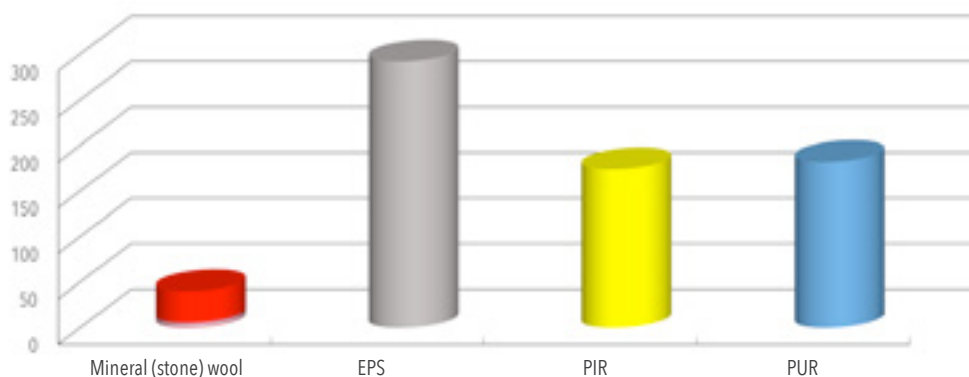

Figure 6. Comparison of the fire load densities of different thermal insulation materials

Bearing in mind the importance of energy efficiency in building in EU and Croatian strategies, when energy renovating existing buildings, but also when constructing new buildings, it is necessary to apply the latest technical solutions and regulations so that by increasing one performance (energy consumption) another is not degraded (behaviour in case of fire).

4 MECHANISMS OF FIRE SPREAD OVER FAÇADES

There are three typical scenarios of fire spread over façades (Figure 7):

1. Spread of the external fire onto combustible façade by radiation from the neighbouring, separate building,
2. Spread of the external fire onto combustible façade from the source of fire located next to the façade, with the consequence of radiation or direct exposure to fire (litter on the balcony, parked cars etc.),
3. An internal fire that has started in a space inside a building spreads through openings in the façade (windows, doors etc.) onto higher or lower floors.

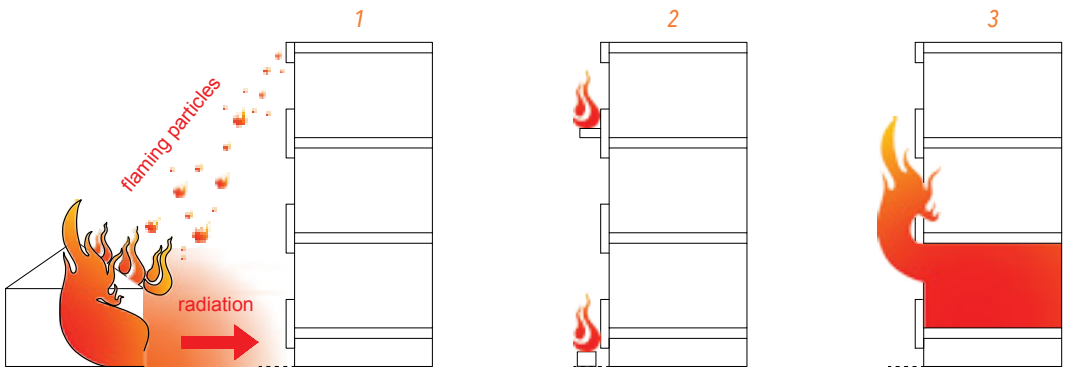

Figure 7. Three typical scenarios of fire spread across façades



Figure 8. Fire coming through the opening on the building after flashover [10]

If there is no fast intervention (either by firefighters or by a sprinkler system) a fire in an indoor space can develop to flashover phase, when the flame is most likely to come out through the openings on the façade (windows or doors). By the time glass cracks and a fire breaks outside, flames can reach up to 5 metres above the edge of the opening regardless

of the façade system and the type of material used (Figures 8 and 9), which is both influenced by a façade system and by airflow speed.

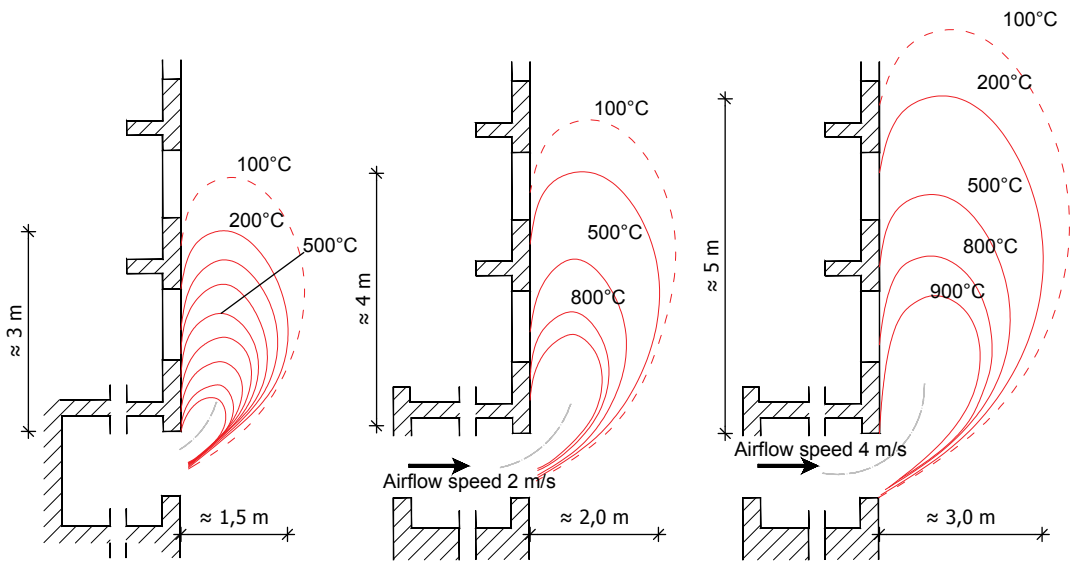

Figure 9 Flame heights with marked temperatures across façade depending on airflow [12]

When flames (whether from an internal or external source) spread onto the external layer of the façade, further spread across the façade will depend on façade system properties where the most important factors are as follows:

- **Reaction to fire properties of the materials** on a façade which influence the speed of fire spread on the envelope of a building. The mechanism of fire spread through openings on a ETICS façade with combustible insulation is shown in Figure 10.
- **The existence of cavities in a façade** (which are part of façade systems, e.g. ventilated ones, or the ones formed by parts of the façade delaminating during fire). If fire enters a cavity, due to the chimney (stack) effect, it can be extended five to ten times from its initial length, regardless of the properties of the material facing the ventilated layer. If fire barriers are not used, the described effect will cause fast vertical fire spread, which can be “hidden” below the cladding on the façade (Figure 11).
- **Openings on a façade** (windows, doors etc.) which enable fire to return to and enter the indoor space of a building, when it can further spread from floor to floor according to the above described mechanism.

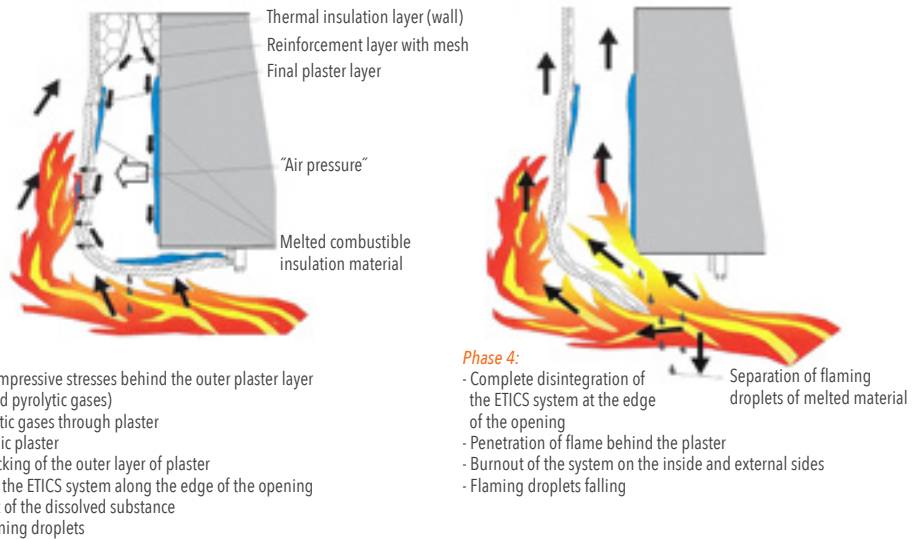
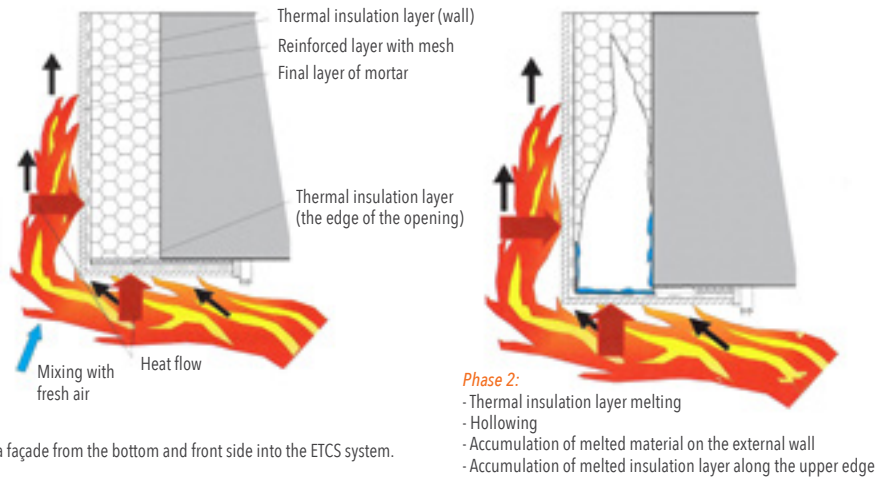

Figure 10. Development of fire across a façade due to combustible thermal insulation [13]

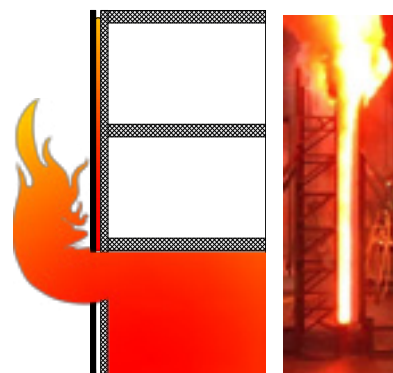

Figure 11. Fire spread through a ventilated layer in a façade [14]

If fire spread across a façade with ETICS system with a combustible material has not been prevented (either by a firefighter intervention or by sprinkler system activation etc.), then fire will spread from floor to floor in a multi-floor building within time shown in Figure 12.

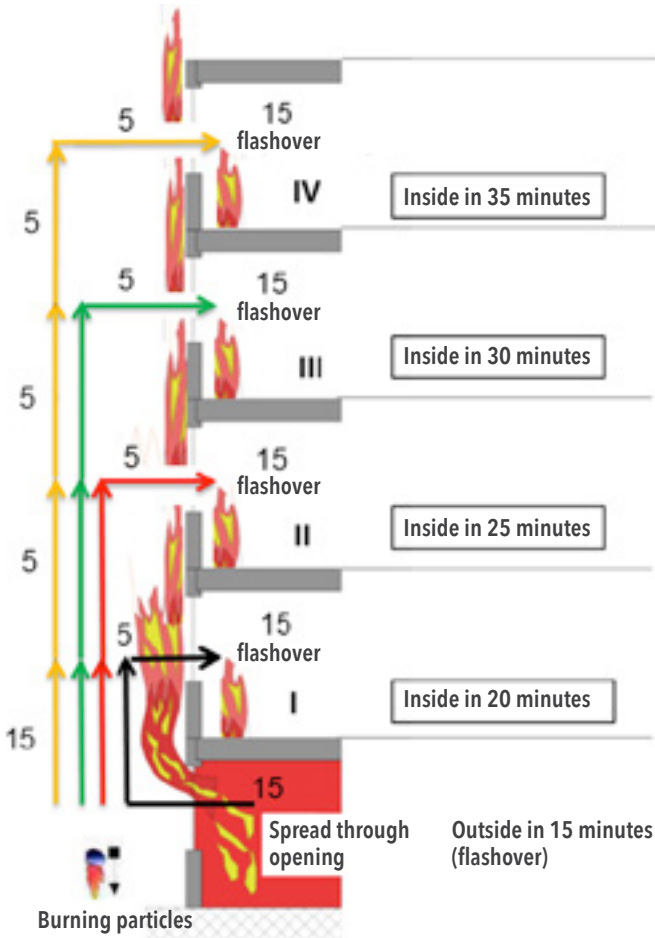

Figure 12. Approximate time of fire spread to other floors with ETICS façade system with combustible insulation [15]

The objective of fire protection measures regarding façades, is the prevention of fire spread to more than two floors above the floor on which the fire started before the firefighters' intervention. The firefighters' intervention should prevent falling of the combustible parts of a façade or larger parts of an external wall [15].

The research in this area has shown that the danger of fire spread along the façade is higher if fire is spread from the interior space by flames spreading through openings in a façade (case 3 in Figure 7) than if an outdoor fire is spread (case 1 and 2 in Figure 7). That is why a large scale testing of façades, which are used in some European countries, (e.g. BS 8414-1 in Great Britain [16], SP FIRE 105 [17] in Sweden or MSZ 14800-6 [18] in Hungary) is based on exposing façades to simulated fire occurred in an enclosed space after the flashover phase. The example of a large scale façade testing in fire can be found in Annex 2 of the Guidelines. This testing has clearly shown that the testing and classification based on reaction to fire properties based on SBI (single burning item) testing cannot be applied to façades.

4.1 Overview of larger fires with their spread related to façade type

Although the fires that have started and spread in buildings through combustible materials on façades are relatively rare, they can have considerable consequences both in terms of property damage and casualties. Below are some examples where the analysis of the causes and the spread of fire have shown that their consequences could have been less serious if the façade systems had been properly designed and executed.

4.1.1 MISKOLC APARTMENT BUILDING FIRE, HUNGARY, 2009

In Miskolc, Hungary, on August 15, 2009, fire started in a kitchen on the 6th floor of an apartment building and vertically spread across ETICS façade to the roof. The apartment building had a basement, a ground floor and ten floors. In addition to the property damages (Figure 13), three people were killed. The building was constructed in 1968 and refurbished in 2007. The refurbishment included the façade with ETICS system with polystyrene insulation, a very combustible material. During fire, the smoke quickly spread through the staircase and pipe shafts which had not been properly insulated.

The investigation into the causes and consequences of the fire showed that the following factors had contributed to the fast spread of fire in the building [19]:

- Because of summer weather the windows were open and enabled the fast spread of fire across the façade to the floors above the one where the fire had started,
- The polystyrene insulation on the external walls was installed without non-combustible insulation fire barriers,
- Inadequate installation of insulation, i.e. polystyrene panels were inadequately fixed to the walls,
- 2-3 mm of plaster was applied instead of required 5 mm.



Figure 13. Consequences of fire on the façade of the residential building in Miskolc, Hungary

4.1.2 FIRE IN A HOSTEL BUILDING, DIJON, FRANCE, 2010

The fire which, on November 14, 2010, started in a garbage container and quickly spread vertically across the façade of a nine-floor hostel, and resulted in, in addition to property damages, eleven injured and seven killed people. A strong wind contributed to the fast spread of fire across the façade because it “pushed” flames towards the façade. The photographs

(Figure 14) show that the fire mostly spread in the recessed part of the building with balconies. It is thought that the façade was made of combustible ETICS system, but the detailed documentation on the investigation into the causes and the course of fire has not been disclosed yet.



Figure 14.
Consequences
of fire in Dijon
hostel [20]

4.1.3 FIRE IN CULTURAL TELEVISION CENTER TOWER (TVCC), BEIJING, 2009

The fire occurred on February 9, 2009, in an unfinished building, 159m tall (32 floors). One firefighter was killed, seven people were injured, and the property damages reached 110 million euros. The building consisted of a main tower and two angular wings, on the east and west sides (Figure 15). The north and the south side of the tower were installed with glass curtain walls, and the cladding of the east and west façade was made of titanium-zinc alloy panels, with the extruded polystyrene (XPS) filling and a layer of air between the cladding and the insulation layer. The building was designed by the well-known Dutch architects Rem Koolhaas and Ole Scheeren.

According to available information, the fire started on the roof and was caused by illegal welding. The welding sparks got into the interior of metal panels and ignited the insulation layer made of XPS. Titanium-zinc alloy usually melts at 400° C. Flaming particles produced by burning XPS were falling off the roof and caused the fire to spread across the façade towards lower floors. Due to a strong wind, the whole tower was in flames within 20 minutes (Figure 15b) [21]. The fire spread into the interior of the building which was not completely furnished at the time.

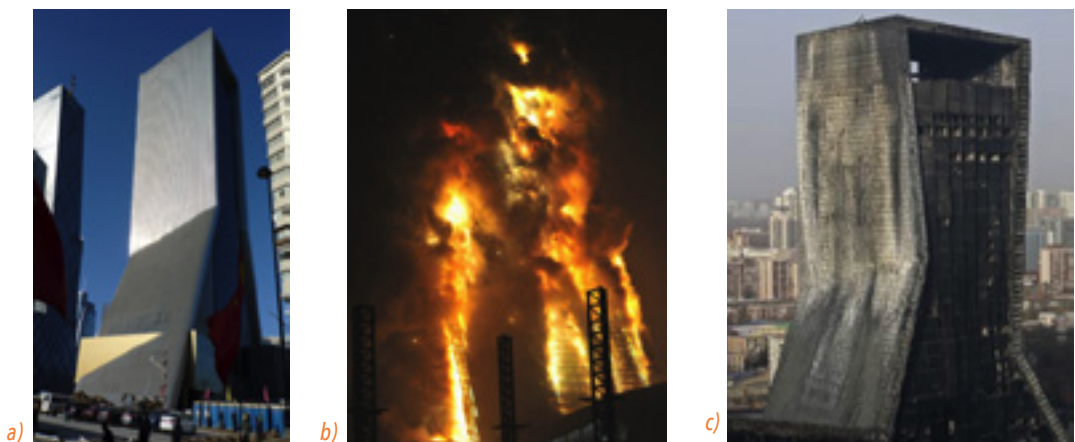

Figure 15. TVCC building a) before, b) during and c) after the fire [22]-[24]

Unlike most fires in buildings, which start indoors and spread outward from lower to higher floors, the fire shown in this example had a completely different course. Combustible insulation materials without fire barriers, namely the use of inadequate materials for façade cladding, definitely contributed to the extensive spread of fire.

4.1.4 CVJETNO NASELJE STUDENT DORMITORY FIRE, ZAGREB, 2017

The fire that started on the roof of a student dormitory on February 22, 2017, vertically spread along the façade of the adjacent building towards next three floors (Figure 16). The exact cause of the fire is not yet known. However, according to the photographs of the fire, it can be claimed that the fire started on the roof of the lower building. Combustible thermal insulation of the façade system and a strong wind definitely contributed to the fast spread of flames and smoke on the façade.



Figure 16. a) Fire in student dormitory b) the façade after the fire was extinguished [11], [25]

Pursuant to the amendments for the *Ordinance on fire resistance and other requirements for buildings in case of fire* (Official Gazette 87/15) July, 2015, buildings such as students dormitory in Zagreb, fall into quite demanding category of buildings with regards to fire protection (so called subgroup ZPS5 see page 25). They must have thermal insulations pursuant to the requirements of the above mentioned Ordinance; if combustible thermal insulation is used, which is permitted by the Ordinance, layers of non-combustible materials must be added, which will prevent fire to spread fast across a façade. Aforementioned rule is force since August, 2015.

5 CROATIAN REGULATIONS REGARDING FIRE PROTECTION OF BUILDINGS

The design of buildings in the area of fire protection is regulated by the Building Act (Official Gazette 153/13, 20/17), Fire Protection Act (Official Gazette 92/10) and a number of bylaws, the recognized technical practice rules and standards (Figure 17).

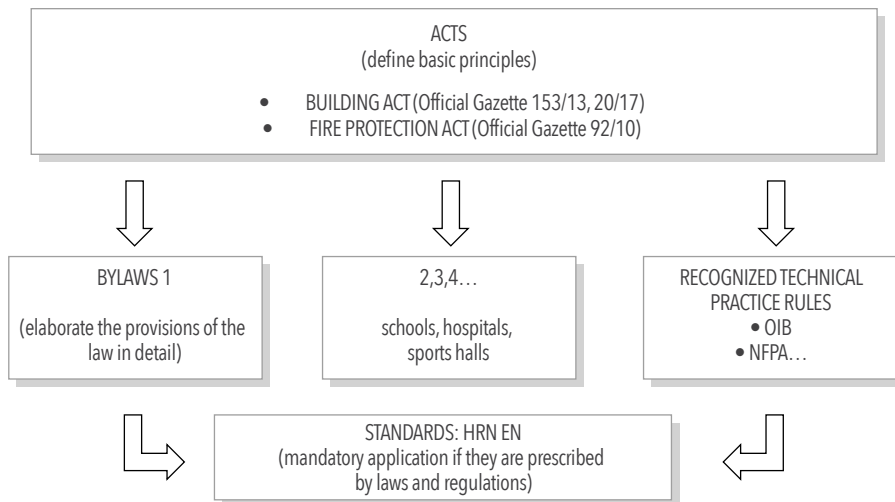

Figure 17. General scheme of Croatian legislation regarding fire protection

There are still some areas of fire protection, for instance, requirements for design of hospitals, schools, nursery schools, retirement homes etc. which have not yet been regulated by Croatian legislation. *Ordinance on Fire Resistance and other Requirements for Buildings in Case of Fire - Official Gazette 29/13 and 87/15*, (hereinafter Ordinance), passed in 2013 and amended in 2015, is the basic bylaw for fire protection. It is harmonized with the European requirements. *The Ordinance* was defined as a basic module which has to be upgraded with the modules for the buildings of the above purposes (schools, hospitals, nursery homes, etc.). In the meantime - until relevant Croatian regulations are not brought - the recognized technical practice is applied for these types of buildings; most often NFPA 101, Life safety code [26] (NFPA - National Fire Protection Association) or Austrian guidelines OIB Richtlinie 2 (OI B - Österreichisches Institut für Bautechnik [27]). These regulations define fire protection measures that have not been regulated by Croatian legislation, for instance, when determining the maximum area of fire and smoke compartments or the need for systems of active protection (sprinklers, fire alarms etc.). Otherwise, the existing Croatian legislation for fire protection must be applied. Thus, the requirements from the above mentioned *Ordinance* regarding reaction to fire of insulation materials for façades are applied since they cover the topic thereof, and foreign legislation is not applied.

5.1 Fire Protection Act (Official Gazette 92/10) – overview of the most important paragraphs relevant to the Guidelines

The Fire Protection Act (Official Gazette 92/10), hereinafter The Act, like every act, does not define details, but outlines general principles, which are elaborated in bylaws. Thus, Article 25, paragraph 1 of the Act, determines that buildings must be designed and constructed according to the basic (essential) requirements for fire protection, as defined by the Interpretative document No 2 - *Safety in case of fire* [28].

Article 25, paragraph 1: *When designing and constructing a building, fire protection must be provided, as one of the essential requirements for buildings prescribed by a special regulation regulating physical planning and construction, so that in case of fire:*

- *the load-bearing capacity of the construction can be assumed for a specific period of time,*
- *the generation and spread of fire and smoke within the works are limited,*
- *the spread of fire to neighbouring construction works is limited,*
- *occupants can leave the works or be rescued by other means,*
- *the safety of rescue teams is taken into consideration.*

None of these requirements directly refers to façades, although in preventing spread of fire and smoke inside buildings and to adjacent buildings, both façades and roof structures are very important as possible fire transmitters since their combustibility or wrong installation can cause fire spread to adjacent apartments and/or adjacent buildings.

The design data, which are elaborated in the main design, are obtained from the fire protection report as set out in Article 28 of the Act:

Article 28, paragraph 1: *The data for designing fire protection measures in the main design, which is the integral part of the main design certificate, of the building permit, respectively, of the construction decision pursuant to regulations governing construction, are obtained from the fire protection report which has been the basis for its execution.*

Article 28, paragraph 2, determines which buildings require fire protection report.

Article 28, paragraph 2: *A fire protection report is required only for the buildings in Group 2.*

The buildings in Group 2 are defined by the *Building Group Classification Ordinance according to Need for Fire Protection Measures* (Official Gazette 56/2012), and they include more complex structures in terms of fire protection. Article 28, paragraph 3, defines who can make a fire protection report.

Article 28, paragraph 3: *A fire protection report is made by the persons authorized to make fire safety reports which are verified by their signature and stamp.*

As mentioned earlier in these Guidelines, the basic provisions of the Fire Protection Act have been elaborated in bylaws (regulations) of which the most important is the above mentioned Ordinance since it has been harmonised with the European legislation and European practice. This is also the only regulation that sets out the requirements for the fire protection of façades.

5.2 Ordinance on Fire Resistance and other Requirements for Buildings in Case of Fire (Official Gazette 29/13, 87/15)

The Ordinance deals with the requirements for fire protection in buildings, which is elaborated in the following chapters:

- Basic provisions,
- Fire resistance of structures and elements,
- Reaction to fire of construction products,
- Prevention of fire and smoke spread inside buildings,
- Prevention of fire spread to adjacent buildings,
- Smoke and heat exhaust systems, and overpressure systems
- Evacuation routes,
- Safety of rescue teams.

This chapter deals with the classification of buildings into subgroups according to the level of required fire protection, which affects the fire protection requirements for façades.

5.2.1 Classification of buildings in subgroups according to the level of required fire protection.

SUBGROUP 1 BUILDINGS - ZPS 1

Detached buildings accessible to the firefighters from minimum three sides for the purpose of extinguishing fires from the ground level, they have up to three above-ground floors, with the height of the highest residence floor of maximum 7 meters measured from the fire service access level or from where the evacuation of endangered people is possible, and which contain one resident or one business unit of up to 400 m² gross floor area and with up to 50 users.

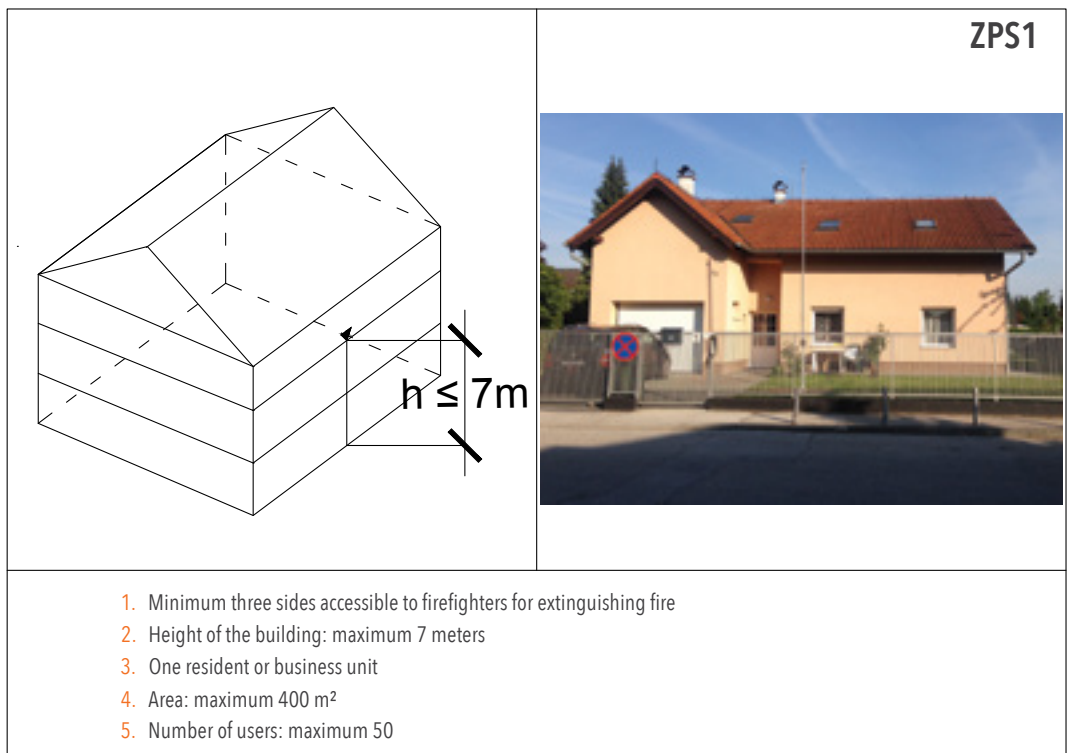

Figure 18. Schematic illustration of a typical building in subgroup 1 with a photograph

SUBGROUP 2 BUILDINGS - (ZPS 2)

Detached and semi-detached buildings, with up to three above-ground floors, with a 7 meter height of the residence floor measured from the outside elevation from the fire service access level and from where the evacuation of endangered people is possible, and which contain maximum three resident or business units of single gross floor area up to 400 m² and with a total of up to 100 users.

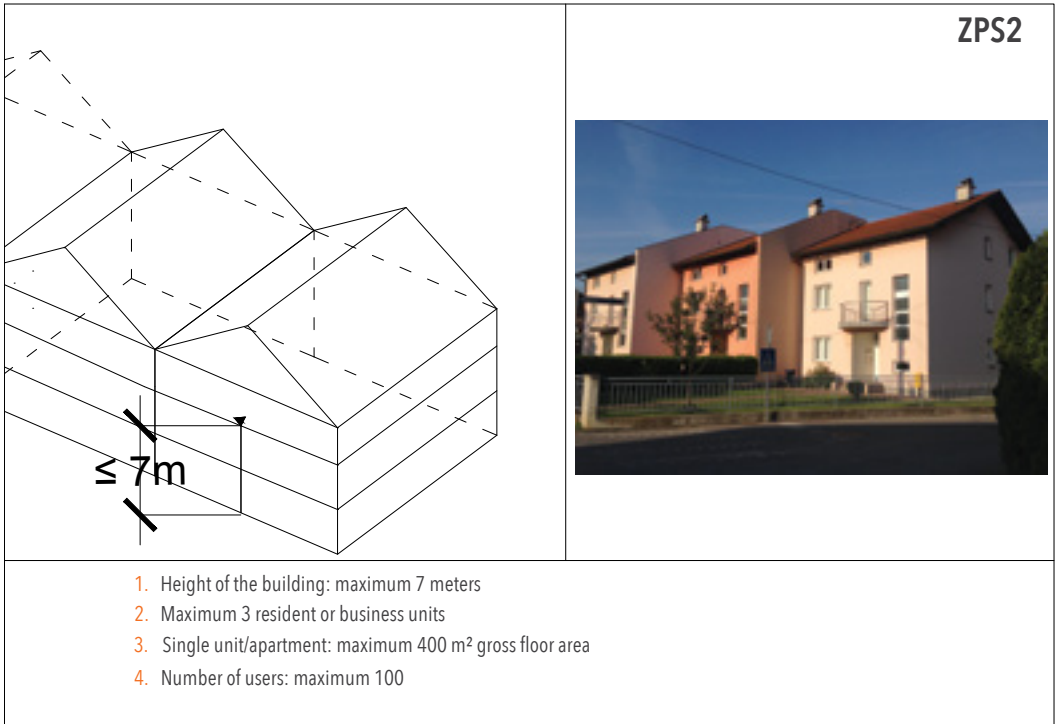

Figure 19. Schematic illustration of a typical subgroup 2 building with a photograph

SUBGROUP 3 BUILDINGS - (ZPS 3)

Buildings with three above-ground floors with the height of the highest residence floor up to 7 meters measured from the outside elevation from the fire service access level and from where the evacuation of endangered people is possible, where fewer than 300 persons gather. These buildings are not included in subgroups 1 and 2.

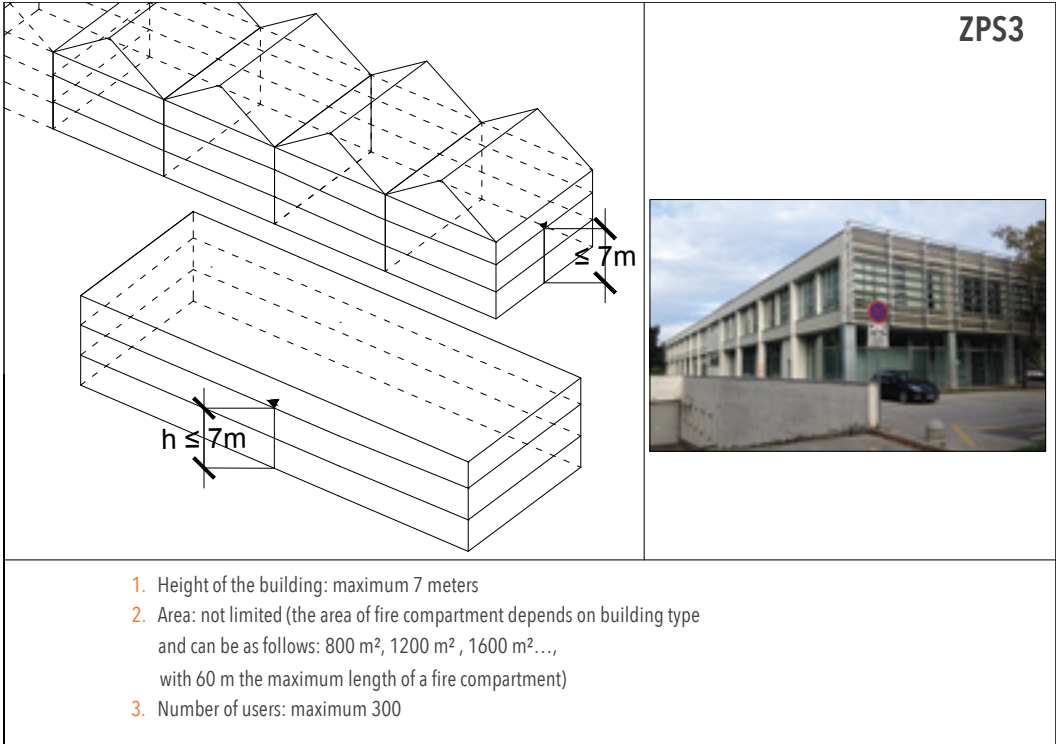

Figure 20. Schematic illustration of a typical subgroup 3 building, with a photograph

SUBGROUP 4 BUILDINGS (ZPS 4)

Buildings with up to four above-ground floors with the height of the highest residence floor up to 11 meters measured from the outside elevation from the fire service access level and from where the evacuation of endangered people is possible, and which include one resident or business unit without limitation in gross floor area or more resident/business units of single gross floor area up to 400 m² and a total of up to 300 users;

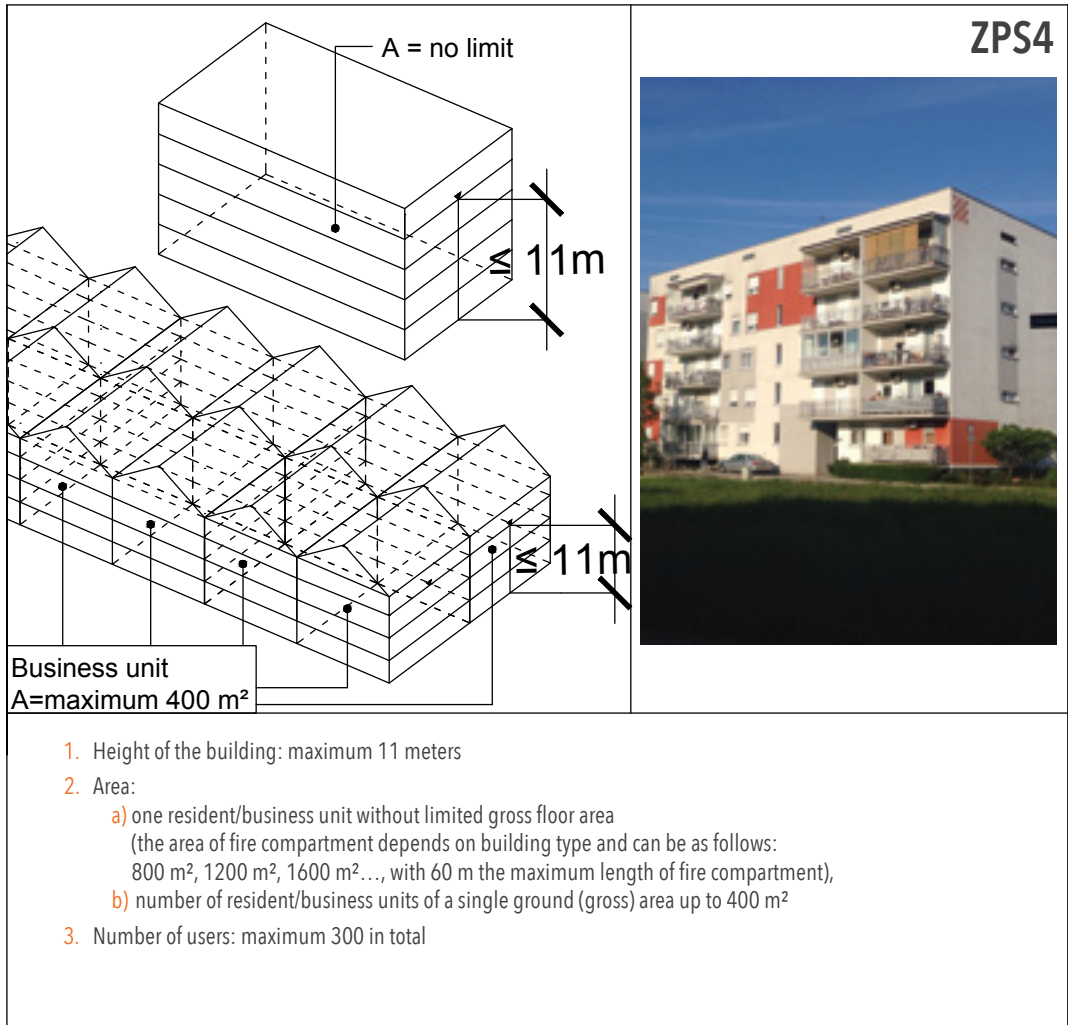

Figure 21. Schematic illustration of a typical subgroup 4 building, with a photograph

SUBGROUP 5 BUILDINGS (ZPS 5)

Buildings with the height of the highest residence floor up to 22 m measured from the outside elevation from the fire service access level and from where the evacuation of endangered people is possible, and which do not belong to the subgroups ZPS 1, ZPS 2, ZPS 3 and ZPS 4, as well as buildings which mostly consist of underground stories, buildings where immobile persons or persons with reduced mobility reside, persons that cannot be independently evacuated (hospitals, retirement homes, psychiatric institutions, nursery schools, and the like), and buildings with residents with limited mobility for security reasons (prisons etc.), and/or single spaces where more than 300 persons can gather.

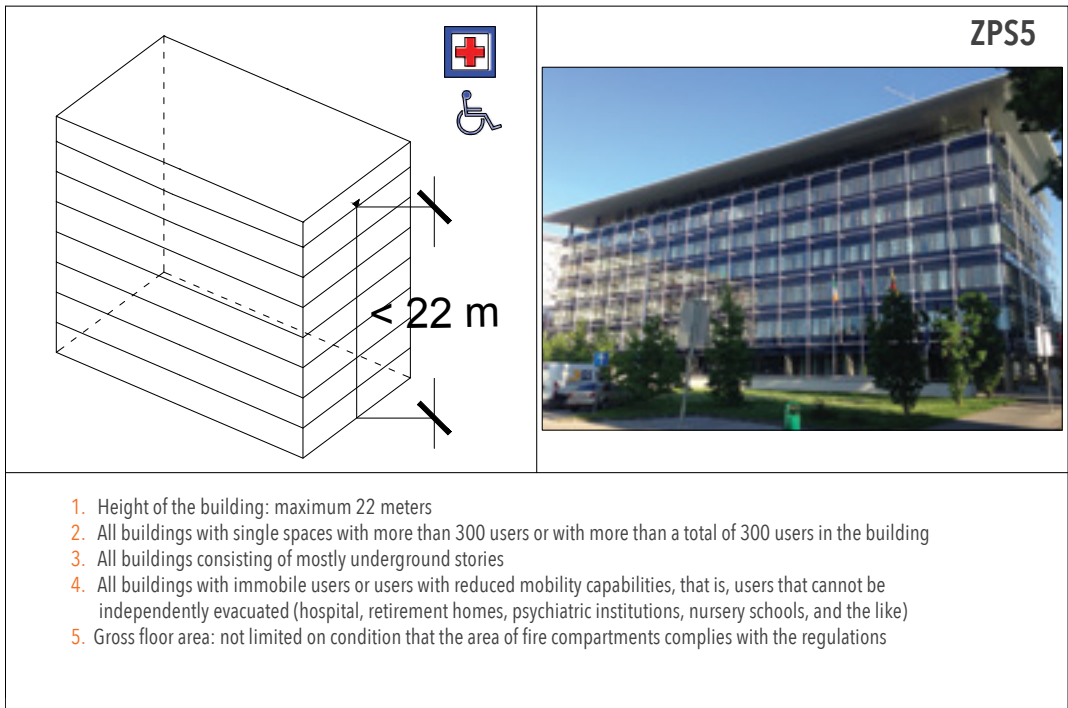

Figure 22. Schematic illustration of typical subgroup 5 building, with a photograph

HIGH-RISE BUILDINGS

Buildings with the height of the highest residence floor up to 22 m measured from the outside elevation which enables the intervention by firefighters and the evacuation of endangered people, by using fire truck ladders or tower ladders or hydraulic platforms.

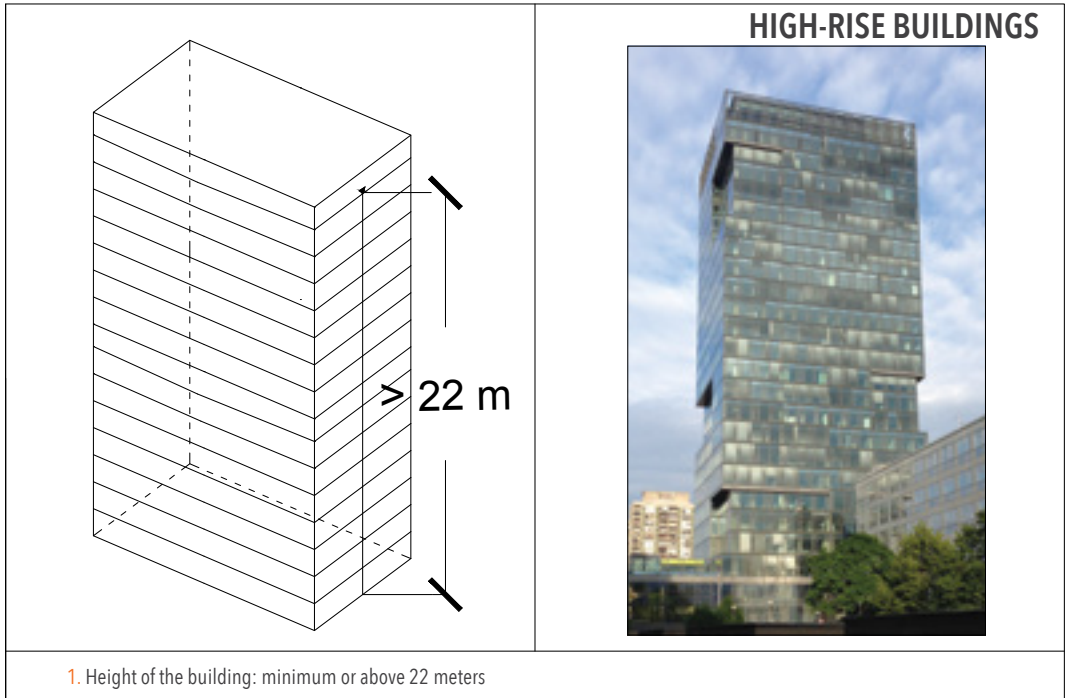

Figure 23. Schematic illustration of a typical high-rise building, with a photograph

The requirements for each subgroup of buildings are shown in Table 2, for easier comparison.

Table 2. Requirements for classification of buildings into relevant subgroups according to the rate of fire protection

| Requirements / building subgroup | ZPS 1 | ZPS 2 | ZPS 3 | ZPS 4 | ZPS 5 | High-rise buildings |
|---|----------------------|-----------------------|-------------|--|----------------------|--|
| Height of a building | 7 m | 7 m | 7 m | 11 m | < 22 m | ≥ 22 m |
| Total floor area | ≤ 400 m ² | ≤ 1200 m ² | No limit | No limit | No limit | No limit Special Ordinance being prepared |
| Gross floor area of single residential/ business unit | ≤ 400 m ² | ≤ 400 m ² | No limit | No limit if there is one residential or business unit ≤ 400 m ² per residential/ business unit | No limit | No limit Special Ordinance being prepared |
| Maximum number of units | 1 | ≤ 3 | No limit | No limit | No limit | No limit Special Ordinance being prepared |
| Number of users | ≤ 50 total | ≤ 100 total | ≤ 300 total | ≤ 300 total | ≥ 300 in single unit | No limit Special Ordinance being prepared |

5.3 Detailed overview of Ordinance articles on the requirements regarding façade execution

This part of Ordinance covers the articles dealing with the requirements with regards to the classification or the reaction to fire of thermal insulation on façades and their installation, fire barriers/layers on buildings with combustible insulation.

5.3.1 REQUIREMENTS REGARDING REACTION TO FIRE OF FAÇADE MATERIALS

According to the Ordinance, reaction to fire classes of façade materials, and other construction elements are related to the subgroups of buildings (defined in chapter 5.2.1) and their position in the buildings thereof (on a façade, inside a building, on the evacuation route and other).

Thus **Article 6, paragraph 1**, states that: a construction product installed in a building must meet the requirements regarding reaction to fire according to Annex 2, tables 4, 5, 6, 7, 8, 9, 10, 11 and 12 of this Ordinance, pursuant to the Croatian standards HRN EN 13501-1 and HRN EN 13501-5.

In the Ordinance, Table 5 relates to the properties of the reaction to fire of internal wall coverings and finishing layers, Table 6 relates to construction products for floors and ceilings, Table 7 deals with roofs, Table 8 relates to air supply and ventilation channels, Table 9 to the fillers for connection lines, Table 10 to fence fillings, Table 11 to double and hollow floors, and Table 12 to covered parking lots and garages.

The requirements regarding the reaction to fire of façades are stated in Table 4 of the Ordinance, and quoted here in Table 3. Regarding the requirements for façades, there is a difference depending whether the entire façade system has been tested and classified according to reaction to fire properties (end-use conditions) or whether the designer has planned the use of classified individual components of façade systems for which there are special requirements for the reaction to fire class.

Table 3. Required classes of reaction to fire in façades

| Construction parts | Subgroups of buildings | | | | | | | |
|--|------------------------|------|------|-------|----|------|---------------------|-------|
| | ZPS1 | ZPS2 | ZPS3 | ZPS4 | | ZPS5 | High-rise buildings | |
| Suspended ventilated elements of façades | | | | | | | | |
| Classified system | E | D-d1 | D-d1 | C-d1 | | B-d1 | A2-d1 | |
| or | | | | | | | | |
| Execution with the following classified elements | | | | | | | | |
| Finishing layer | E | D | D | A2-d1 | or | B-d1 | B-d1 | A2-d1 |
| Substructure | | | | | | | | |
| - dowel type substructure | E | D | D | D | or | D | C | A2 |
| - dotted substructure | E | D | A2 | A2 | | A2 | A2 | A2 |
| Insulation | E | D | D | B | | A2 | A2 | A2 |
| Thermal contact system of façades | | | | | | | | |
| Classified system | E | D | D-d1 | C-d1 | | B-d1 | A2-d1 | |
| or | | | | | | | | |
| Composition of layers with the following classified components | | | | | | | | |
| - finishing layer | E | D | D | C | | B-d1 | A2-d1 | |
| - insulation layer | E | D | C | B | | A2 | A2 | |

The classification of construction products according to reaction to fire properties has been drawn according to the standard HRN EN 135011:2010. Additional clarifications of testing and classification are described in Annex 1 of these Guidelines.

5.3.1.1 Methods of building firewalls and other elements at the border of fire compartment

Design and execution of building firewalls and other structures that divide buildings into fire compartments and their endings on the façade and roof are essential for slowing down the fire spread across façades and/or roofs since the use of non-combustible insulation materials is mandatory in the zones thereof. For the better understanding of the principles of fire spread across the above mentioned parts of buildings, this paragraph gives the overview of articles in the Ordinance regarding the execution of firewalls and their connection with façades or roofs of buildings, with graphic illustrations of typical situations. Further on, there are articles defining the above requirements regarding only firewall finishing in façades or roofs. The articles are given in grey text boxes literally as stated in the Ordinance. Other walls with required fire resistance to some degree resistant firewalls, such as partition walls inside buildings are not covered by these Guidelines.

Article 10, paragraph 1: Internal firewalls are built minimum 0.30 meters above the roof with a non-combustible cover (reaction to fire A1 or A2 – s1,d0) or 0.50 meters above the roof with combustible cover, reaction to fire from E to B.

Article 10, paragraph 2: Instead of of the internal firewall from paragraph 1 of this Article, a two-sided cantilever (left and right to the internal firewall or of double width if only on one side) can be built below the roof having the same fire resistance in the width of 0.50 meters on both sides, but without requiring a mechanical action property (M) for the cantilever. In order to prevent fire spread, the roof surfaces with a combustible cover need to have a non-combustible cover and thermal insulation (reaction to fire A1 or A2-s1,d0) above the cantilever in its full width.

Provisions of the Article 1, paragraphs 1 and 2 are shown in Figure 24.

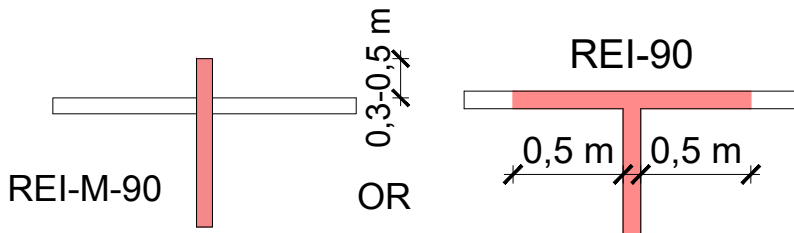

Figure 24. Cross-section of a firewall on the roof

Article 11, paragraph 1: To prevent horizontal spread of fire through windows and other openings in a façade, walls of the same fire resistance as the wall bordering on the fire compartment are built to left and right from the middle of the wall bordering on the fire compartment, each minimum 1 meter wide, or the wall only on one side whose total length is 2 meters, except for building in subgroups ZPS2, ZPS3 and ZPS4, where a total length of 1 meter is permitted.

Article 11, paragraph 2: Instead of the finishing of firewall on a façade, as described in paragraph 1 of this Article, a wall of the same fire resistance which protrudes from the façade, minimum 0.50 meters can be built.

Provisions from Article 11, paragraphs 1 and 2 are graphically illustrated in Figure 25.

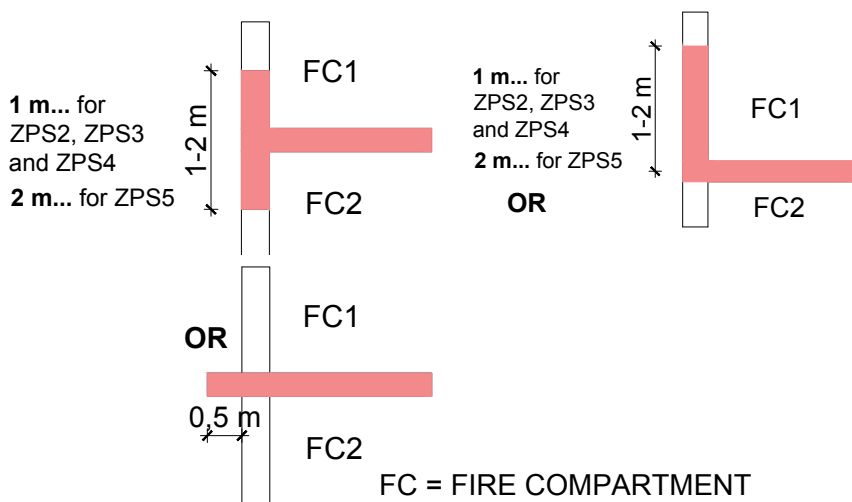

Figure 25. Design of a firewall to prevent horizontal fire spread on a façade (floor plan)

Article 12, paragraph 1: In buildings with angular floor plans where fire compartments are connected at an angle equal to or less than 135° , the horizontal fire spread from one to another fire compartment across corner joints is prevented by building walls of the same fire resistance as the wall bordering the fire compartment and its length is 5 meters from the inner corner where fire compartments are connected. The allowed length for buildings in subgroups ZPS2, ZPS3 and ZPS4 is 3 meters.

Provisions of Article 12, paragraph 1, are graphically illustrated in Figure 26.

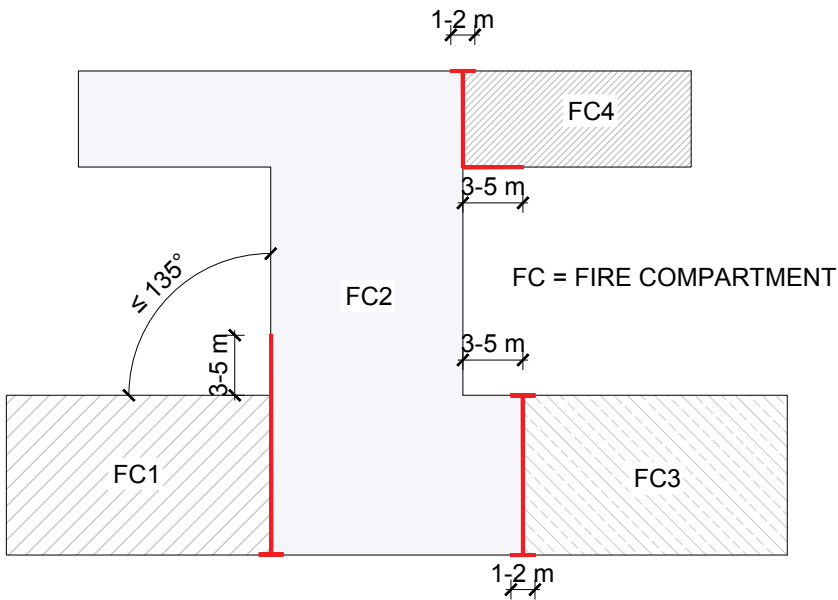

Figure 26. Prevention of fire spread from different fire compartments across a corner joint.

Article 12, paragraph 2: Method of fire spread prevention from different fire compartments across a corner joint is graphically illustrated in Figure 1, in Annex 3 of the Ordinance.

Provisions of Article 12, paragraph 2 are graphically illustrated in Figure 27.

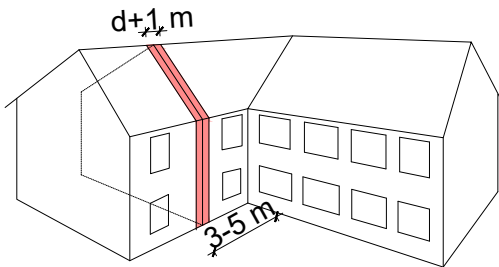

Figure 27a

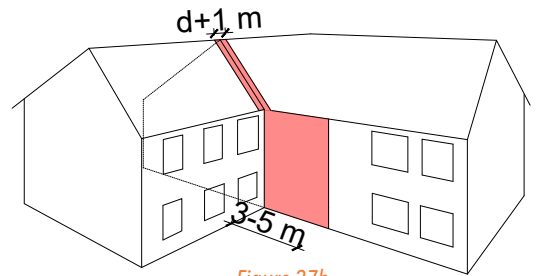

Figure 27b

d - wall thickness

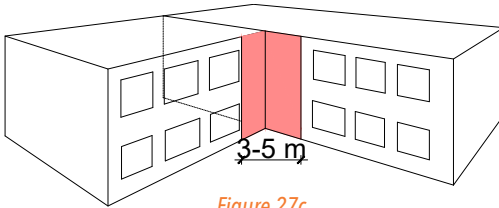

Figure 27c

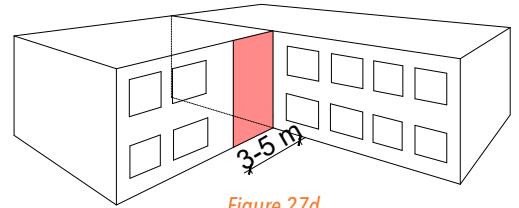
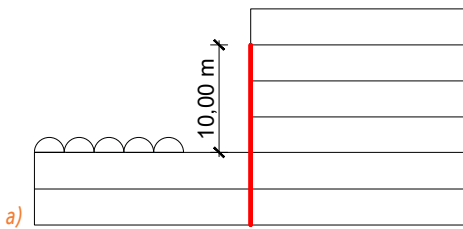

Figure 27d

Figure 27. Firewalls in buildings with angular floor plans

Article 13: To prevent fire spread vertically across adjacent fire compartments, in buildings of different heights, where on the lower roof there are openings at a distance smaller than 5 meters from the façade of a higher building, or there is a ceiling or roof structure which does not meet the required fire resistance, a firewall is built according to Figures 3 and 4 in Annex 3 of the Ordinance.

The provisions from Article 13 are graphically shown in Figure 28 a, b and c.



a)

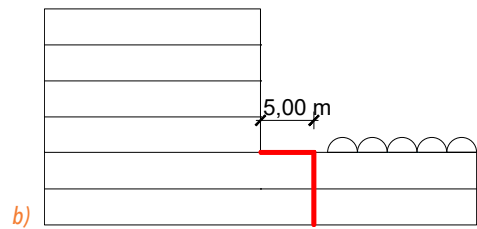

b)

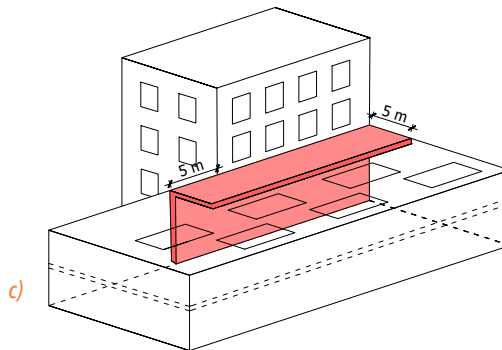

c)

Figure 28. Preventing fire spread from a lower to a higher building a) by building a firewall in a higher building positioned between buildings of different heights, b) by building a horizontal fire barrier in a lower building and c) axonometric illustration of a typical firewall built on a lower building

5.3.2 PREVENTION OF VERTICAL FIRE SPREAD ACROSS THE FAÇADE THROUGH OPENING

5.3.2.1 Fire prevention in separate fire compartments: fire barriers

Article 14, paragraph 1: In order to prevent vertical fire spread across a façade through openings on a lower floor, onto higher stories which are a different fire compartment, it is necessary to build a vertical construction element between the openings (parapet) of the same fire resistance as fire compartments which are separated. The height of the construction element (parapet) which separates floors must be minimum 1.20 meter or longer (it is the sum of vertical and horizontal parts, with required fire resistance).

The provisions of Article 14, paragraph 1, are graphically illustrated in Figure 29.

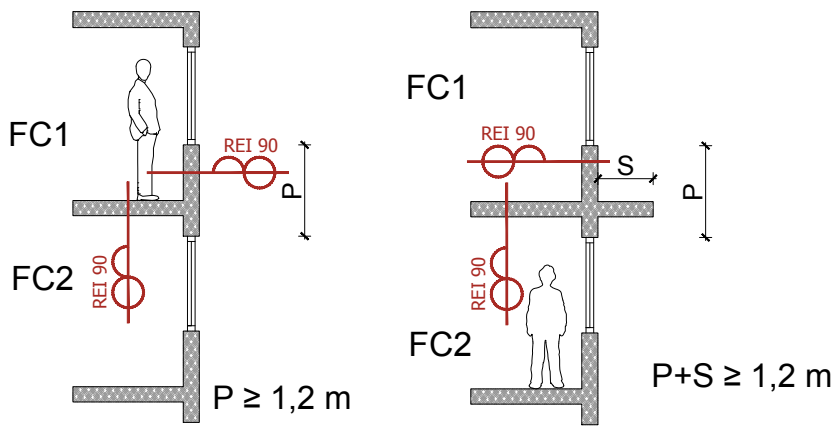

Figure 29. Prevention of vertical fire spread across façade

Article 15, paragraph 1: Façades are built from construction products with reaction to fire classes as given in Table 4, in Annex 2 of this Ordinance.

The required reaction to fire classes in Article 15, paragraph 1, are shown in Table 3 of these Guidelines.

Article 15, paragraph 2: When making thermal contact façade systems with combustible thermal insulation, a fire barrier (reaction to fire A1 or A2-s1,d0) must be made on the construction elements which prevents horizontal fire spread, Article 11, paragraphs 1 and 2, and Article 12, paragraph 1, as well as on construction elements located between openings, preventing vertical fire spread between adjacent separate fire compartments, Article 14, paragraph 1, of this Ordinance.

The provisions from Article 15, paragraph 2 are graphically illustrated in Figure 30a, b and c.

a)

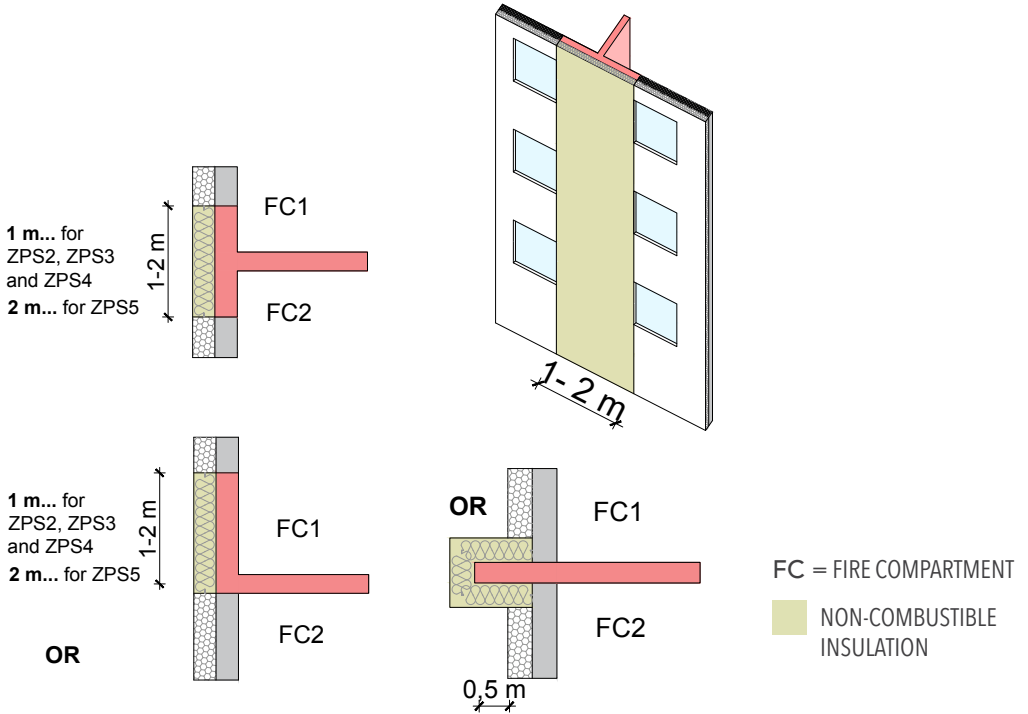

a) prevention of horizontal fire spread from window to window by a firewall and a belt of non-combustible insulation from the outer side of the firewall end (floor plan and axiometric illustration)

b)

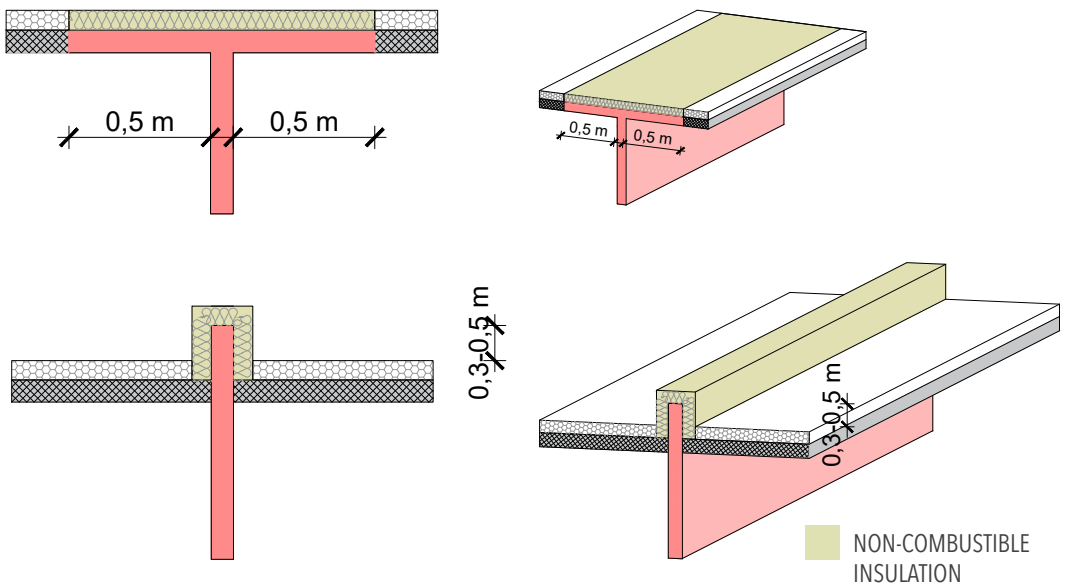

b) finishing of a firewall on a roof with non-combustible insulation material (cross-section and axiometric illustration)

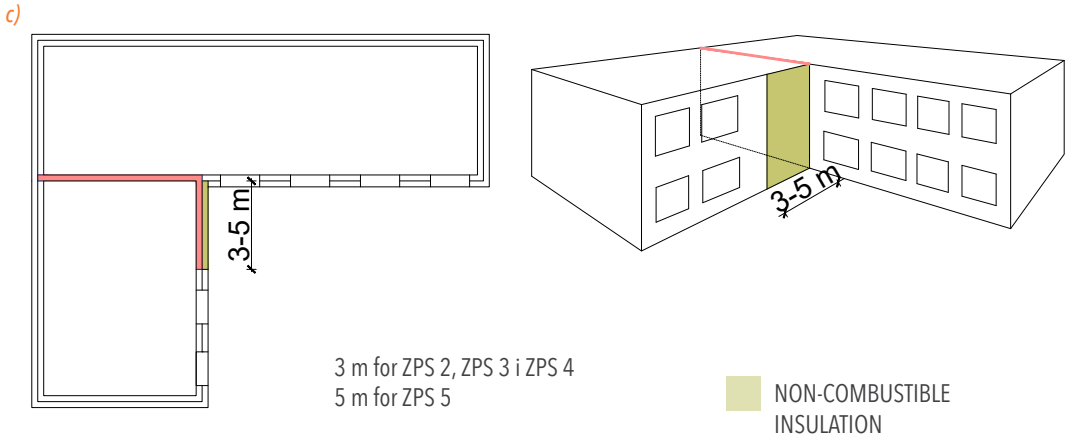

c) prevention of horizontal fire spread in case of corner joint of different fire compartments by a firewall and a belt of non-combustible insulation (floor plan and axiometric illustration)

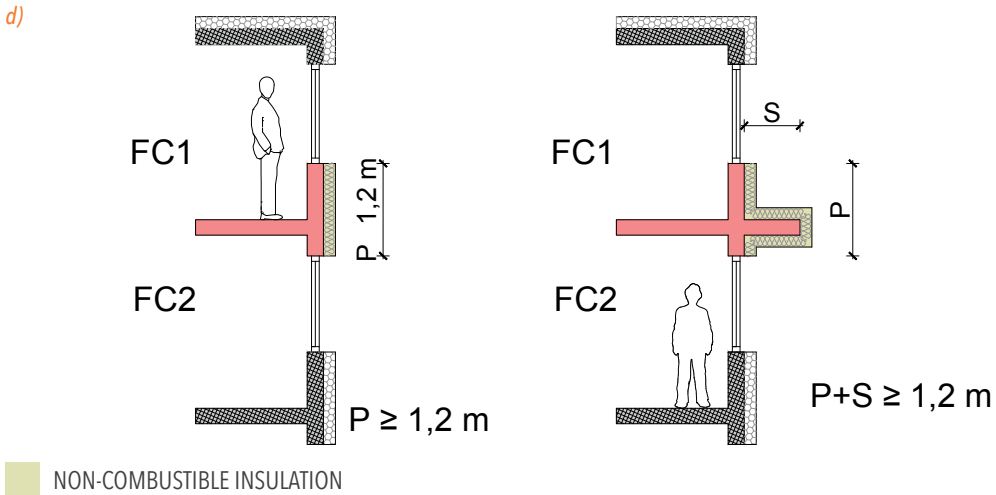

d) prevention of vertical fire spread on a façade with fire barriers (cross-section)

Figure 30. Graphic illustration of Article 15, paragraph 2

Figure 31 shows the example of the execution of a fire barriers (reaction to fire class A1 or A2-s1,d0).



Figure 31. Example of a vertical fire barrier on a façade

Article 15, paragraph 2: *When installing suspending ventilated elements of a façade it is necessary, both in case of combustible and non-combustible thermal insulation, to prevent fire spread through ventilating layer by a fire barrier which, in classified systems, is executed according to the instructions of the manufacturer and in systems with individual elements according to the accepted rules in technical practice.*

5.3.2.2 Prevention within the same fire compartments: solution with fire barriers for contact systems of façades (ETICS)

5.3.2.2.1 Fire barriers round the openings on a façade

Article 15, paragraph 3: *In order to prevent fire spread across the façade in buildings belonging to subgroup ZPS 4 considered as one fire compartment and with contact system façades with combustible insulation, (fire barrier) is installed directly around the clear span of opening sideways and above (windows, doors etc.) or horizontally above the opening 30 cm to the left and right from the final edge of the opening.*

Provisions of Article 15, paragraph 3 is graphically illustrated in Figure 32.

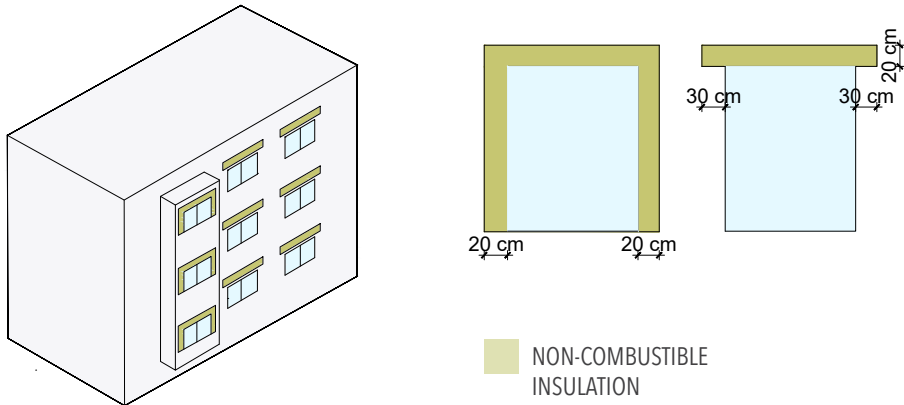

Figure 32. Prevention of vertical fire spread by using fire barriers made of non-combustible insulation materials built in either above or round the opening on a façade [15]

5.3.2.2.2 Horizontal continuous belt of non-combustible materials

Article 15, paragraph 4: *Instead of the method of execution described in Paragraph 3 of this Article, thermal insulation belonging to reaction to fire class A1 or A2-s1, d0, can be installed as a horizontal continuous band minimum 30 cm wide round the entire building on alternating floors, maximum 50 cm above the top edge of the opening. Non-combustible barriers are glued and mechanically fixed on the façade wall so that, in case of fire, elements of thermal insulation do not fall off.*

Provisions of Article 15, paragraph 4 are graphically illustrated in Figure 33.

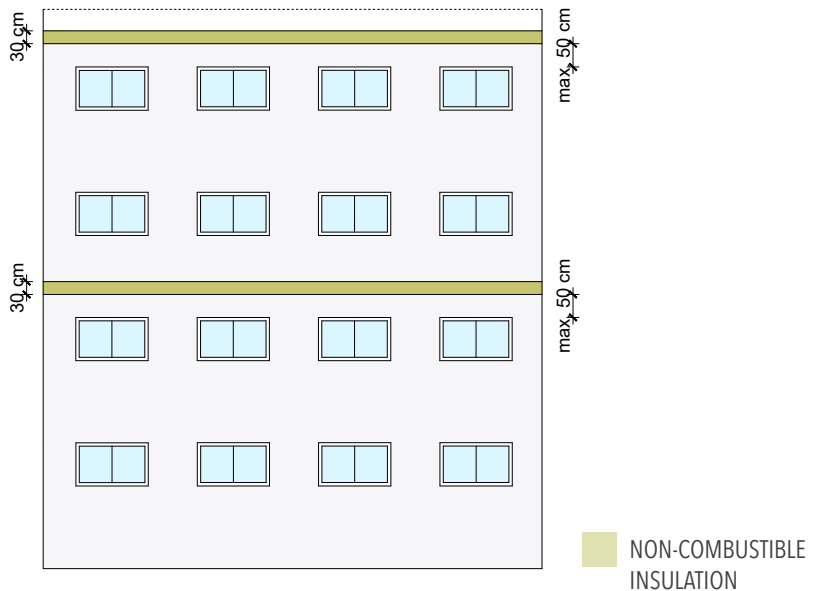

Figure 33. Prevention of vertical fire spread by a horizontal continuous belt of a non-combustible material built in the façade on alternating floors [15]

5.3.2.3 A SAME FIRE COMPARTMENT: a solution for ventilated façade systems

Article 15, paragraph 5: In the buildings from Paragraph 3 of this Article, when installing suspending ventilated façade elements it is necessary, when both combustible and non-combustible thermal insulation is used, to prevent fire spread through the ventilating layer through the openings in a façade or at least on every alternate floor along the entire perimeter of the building. This barrier in classified façade systems is installed according to the manufacturer's instructions, and in systems with individual components according to the accepted regulations in technical practice.

Provisions of Article 15, paragraph 5, are graphically illustrated in Figure 34.

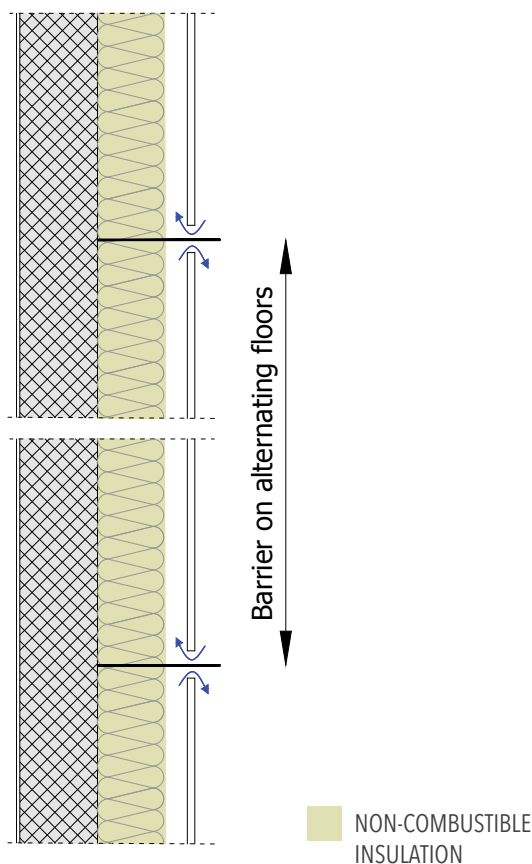

Figure 34. Schematic illustration of barriers in ventilated façade systems which are installed on alternate floors of a building

6 DESIGNER SOLUTIONS FOR COMBUSTIBLE CONTACT AND VENTILATED FAÇADES

6.1 Contact façade systems (ETICS systems)

6.1.1 FIRE BARRIERS AROUND THE OPENINGS ON THE FAÇADE

In case of fire spread through an opening in a façade, a particularly sensitive place is the top edge of the opening (windows and doors), when, due to high temperature, the opening edge decomposes and heat and flames reach the combustible insulation layer of a contact system (mechanism described in Figure 10 in the Guidelines). It can be prevented by additional protection, by installing a fire barrier (material reaction to fire A1 or A2-s1, d0 according to HRN EN 13501-1:2010) to the height of minimum 20 cm above the opening edge and to the width of 30 cm on both sides of the side edge of the opening (Figure 35). The fire barrier can be countersunk to a maximum of 4 cm across the window frame, and should be glued to the external wall along its entire surface in order to avoid cavities between the barrier and the external wall which would enable flames to reach combustible insulation in case of fire.

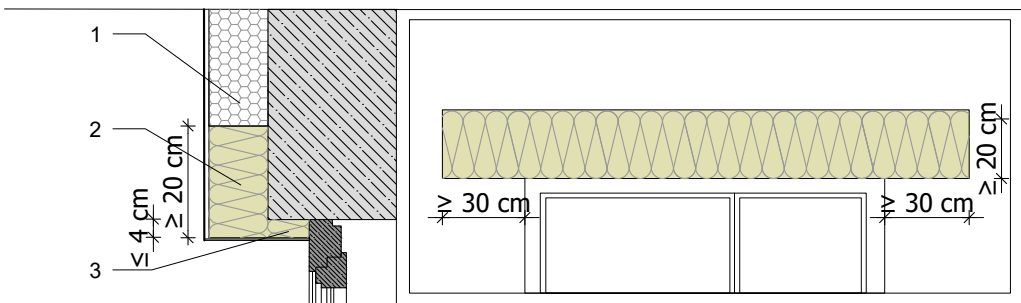

KEY

1. Combustible insulation
2. Non-combustible insulation
3. Non-combustible insulation below the top opening edge

Figure 35. Details of fire barrier installation above the opening on a façade [29]

Around windows in a building with combustible insulation on façade, fire barriers (material of class A1 or A2-s1, d0 according to HRN EN 13501-1:2010) are installed on three sides (upper and two lateral sides) at the height/thickness of minimum 20 cm round the opening (Figure 36). It is also important that barriers are glued to the external wall along its entire surface. If the edge of a window frame does not protrude more than 4 cm from the external wall then it is not necessary to put lateral fire barriers. Barriers above the opening edge will suffice (Figure 36).

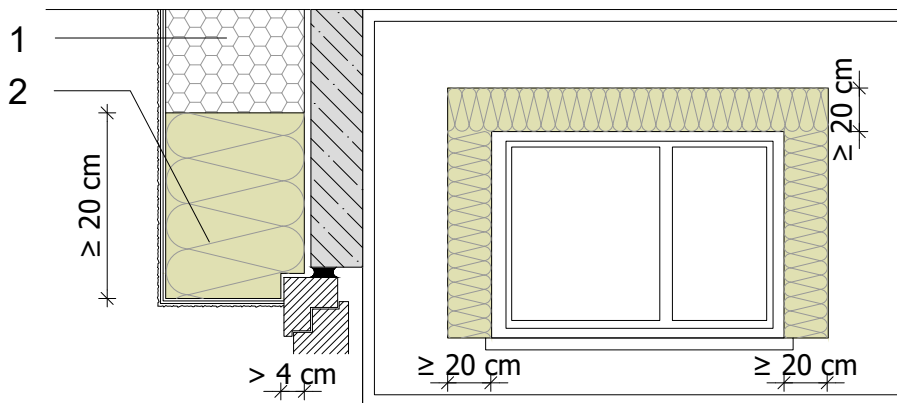

KEY

1. Combustible insulation
2. Non-combustible insulation

Figure 36. Installation details of a fire barrier round an opening on a façade [29]

If shutter boxes are installed directly above the opening, fire barriers (material of class A1 or A2-s1, d0 according to HRN EN 13501-1:2010) are installed on three sides, above the opening and on lateral sides, so that they are glued to the entire surface of the external wall. The barrier above the opening must be installed at the minimum height of 5 cm above the shutter box so that it is properly fixed on the external wall (Figure 37).

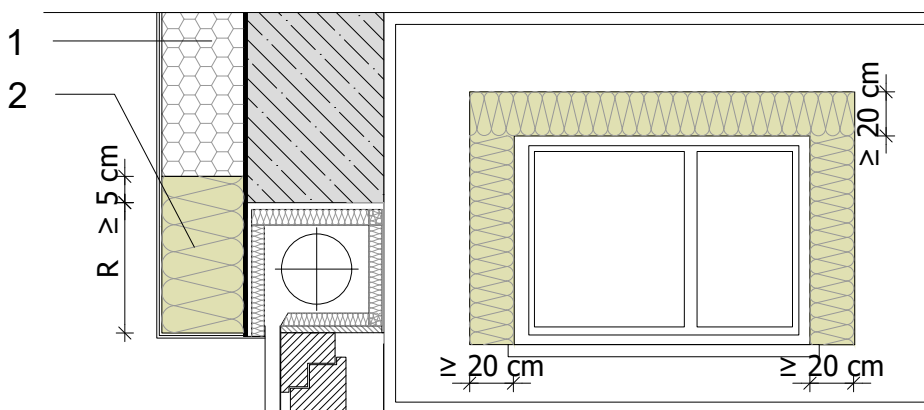

KEY

1. Combustible insulation
2. Non-combustible insulation
- R Shutter box height

Figure 37. Execution details of a fire barrier round a façade opening with a shutter box [29]

If a shutter box is part of the opening/window frame, the whole opening is treated as if there were no shutter box (Figure 38, and the example in Figure 35).

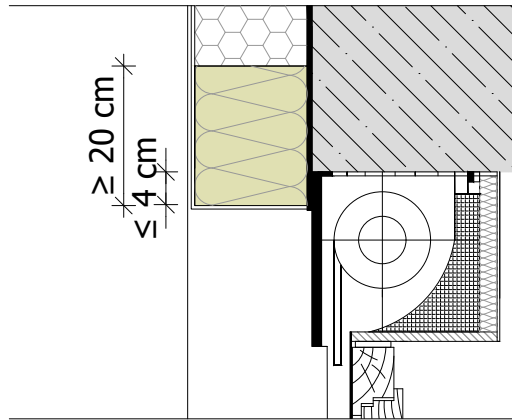
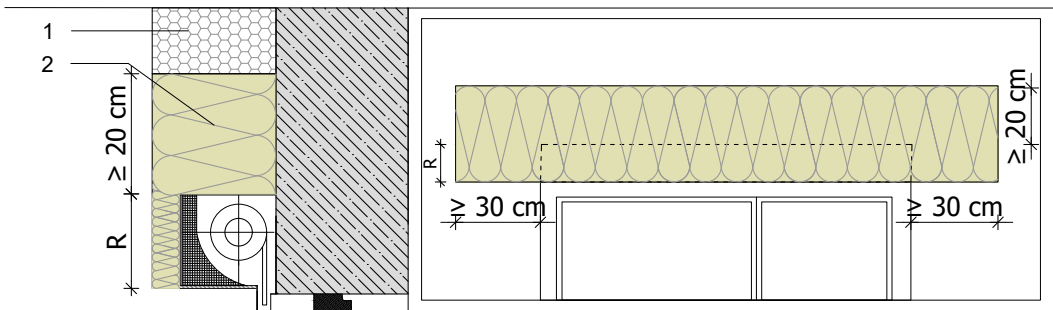

Figure 38. Execution details of fire barrier round a façade opening with a shutter box which is part of the window frame [29]

If a shutter box is installed on an external wall it can be visible or is installed in the layer of the non-combustible material as seen in Figure 39.



KEY

1. Combustible insulation
2. Non-combustible insulation
- R Shutter box height

Figure 39. Execution details of a fire barrier round an opening on a façade with a shutter box on the external wall [29]

If a window-blinds box must be insulated, combustible insulation is allowed up to the thickness of 4 cm. Otherwise, if a greater insulation thickness is required ($\geq 4\text{ cm}$), a layer of non-combustible material has to be applied (Figure 40).

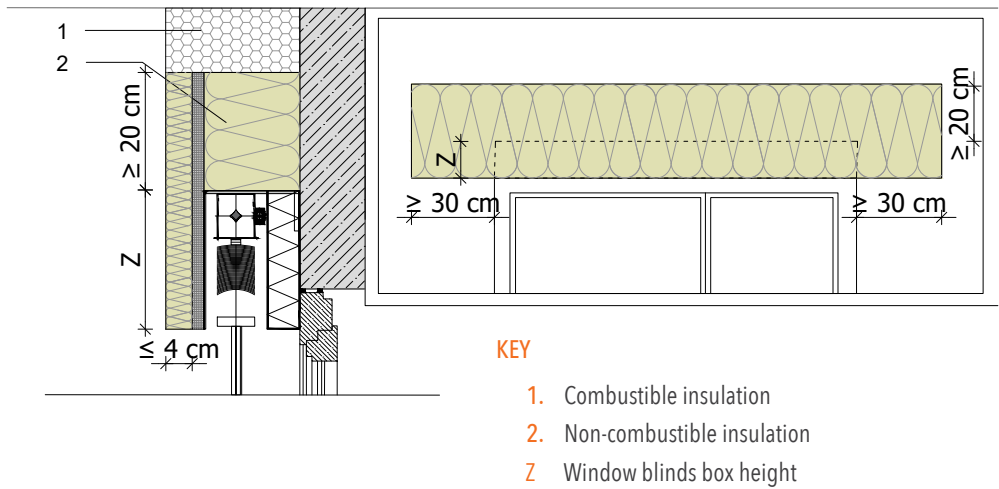

Figure 40. Execution details of fire barrier round the façade opening with a window blinds box on the external wall [29]

6.1.2 HORIZONTAL CONTINUOUS BAND ROUND A BUILDING

Vertical fire spread across façades with combustible insulation can be prevented by installing a continuous band of dimensionally stable, non-combustible thermal insulation (reaction to fire class A1 or A2-s1, d0 according to HRN EN 13501-1:2010) minimum on alternate floor of a building.

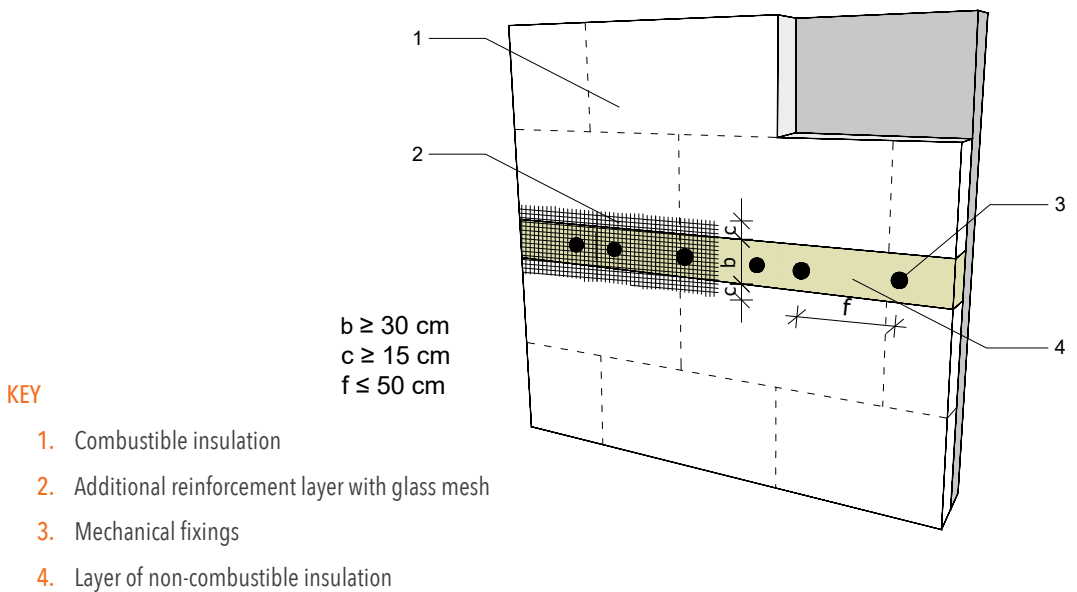

Figure 41. View of the execution of continuous band of non-combustible insulation [30]

Non-combustible insulation layer must be glued along the entire surface. The non-combustible insulation layers are installed at the height up to 50 cm above the top edge of the opening (Figure 43). Two mechanical fixings are installed in the middle of the non-combustible layer at a maximum distance up to 50 cm. Mechanical fixings are installed on the firm surface of the external wall (Figure 42).

According to the recommendations in [30] and the recommendation by the authors of the Guidelines, the continuous non-combustible insulation band should be additionally reinforced with a mesh which is overlapped at the junction at the height of 15 cm on both sides of the band to avoid building damages like cracks caused by high temperature and dynamic instability. The practice in some European countries (for example, Germany) does not require the above additional mesh layer, so it is up to constructors to decide whether to use double mesh on façades, bearing in mind that it is their responsibility if cracks occur.

KEY

- 1. Adhesive mortar for non-combustible insulation
- 2. Adhesive mortar for combustible insulation
- 3. Finishing-decorative plaster
- 4. Combustible insulation
- 5. Non-combustible insulation

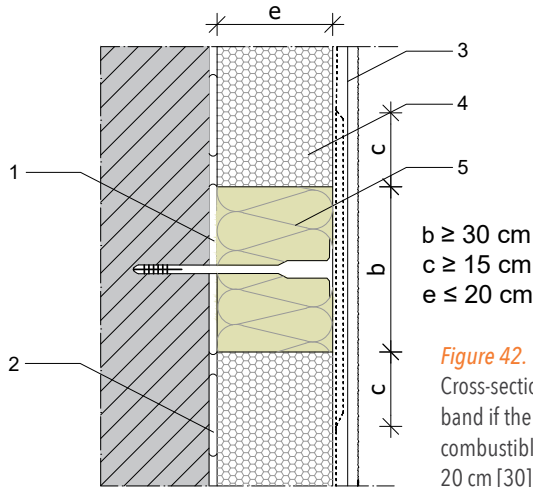

Figure 42. Cross-section of continuous band if the thickness of combustible layer is less than 20 cm [30]

If combustible insulation is $20\text{ cm} < e \leq 30\text{ cm}$ thick, maximum two parallel strips of non-combustible insulation are installed, of which each is $\geq 10\text{ cm}$ thick. If two strips of different thickness are installed, then the thicker strip is directly glued to the external wall, and then a thinner strip is glued to the thicker one. Fixings are installed after the second layer of non-combustible layer has been installed (Figure 44).

KEY

- 1. Non-combustible insulation
- 2. Combustible insulation

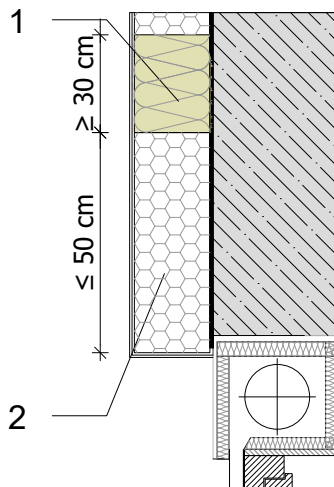

Figure 43. Position of continuous non-combustible band in relation to the opening on a façade [30]

KEY

1. Adhesive mortar for gluing the first layer of non-combustible insulation to the wall
2. Adhesive mortar for gluing the second layer of non-combustible insulation to the wall
3. Adhesive mortar for gluing combustible insulation
4. Mortar for reinforcement layer
5. Combustible insulation
6. Non-combustible insulation

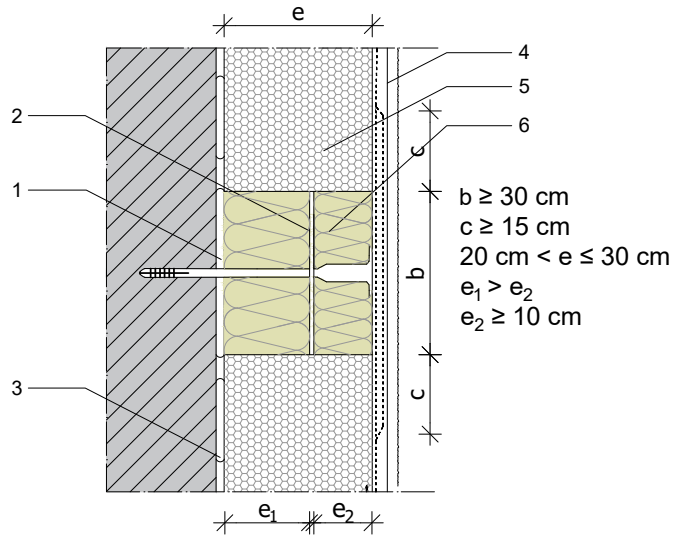
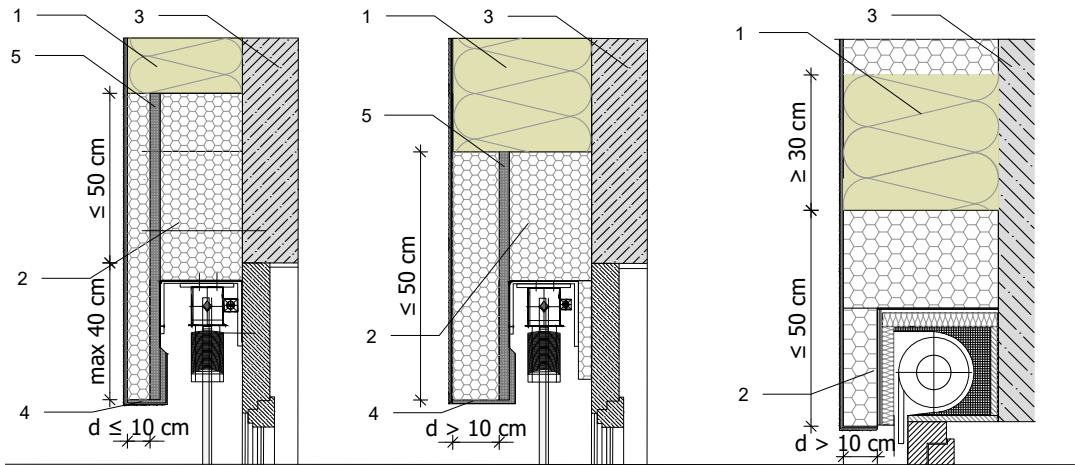

Figure 44. Cross section of the installation of continuous band if combustible insulation is $20 \text{ cm} < e \leq 30 \text{ cm}$ thick [30]

If it is necessary to insulate shutter (or window blinds) boxes on the front side of the wall, the position of continuous band of non-combustible insulation is shown in Figure 45, and it depends on the thickness of the insulation layer of the box, that is, whether it is narrower or wider than 10 cm.



KEY

- | | |
|-------------------------------|--------------------------------|
| 1. Non-combustible insulation | 3. Wall |
| 2. Combustible insulation | 4. Drip edge profile |
| | 5. Final self-supporting panel |

Figure 45. Position of a continuous non-combustible band when shutter or window blinds boxes are on the external wall of the building [29]

6.2 Examples of fire barriers positioning in buildings that belong to subgroup ZPS5

The example of a multipurpose building (residential-business), which according to the Ordinance belongs to the subgroup ZPS 5, shows a proper positioning of vertical and horizontal fire barriers (material of a class A1 or A2-s1, d0 according to HRN EN 13501-1:2010), and according to above mentioned Ordinance provisions (Figures 46 to 55). The building belongs to the subgroup ZPS 5 according to the two criteria: 1) the height of residential part of the building is higher than 11m and lower than 22m and 2) the number of people who can occupy the shopping area can be higher than 300 (with the coefficient of 2.8 persons per m², possible number of people is 478). The building has five floors of which the ground floor is one fire compartment. Above ground floor are residential and office units divided into separate fire compartments. Each fire compartment with residential and business parts is located on two floors. In addition, evacuation staircases are also a separate fire compartments.

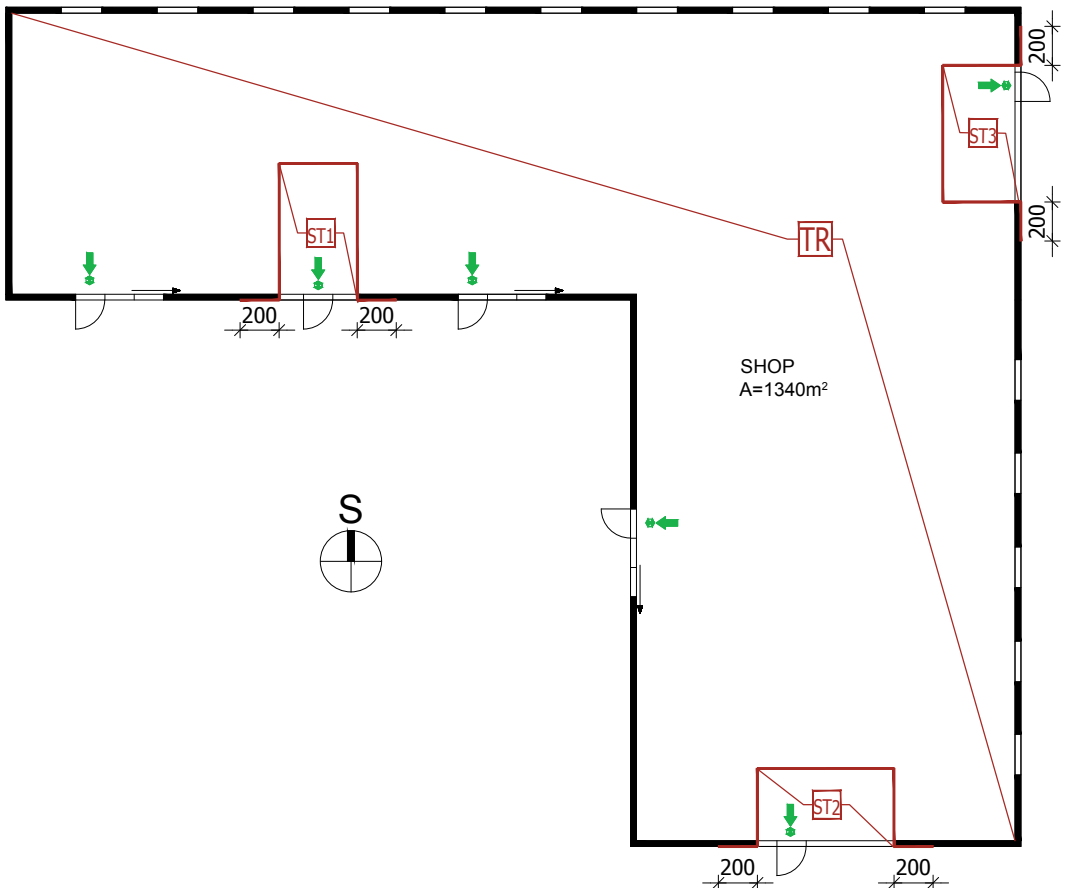

Figure 46. Schematic illustration of a ground floor – a floor plan

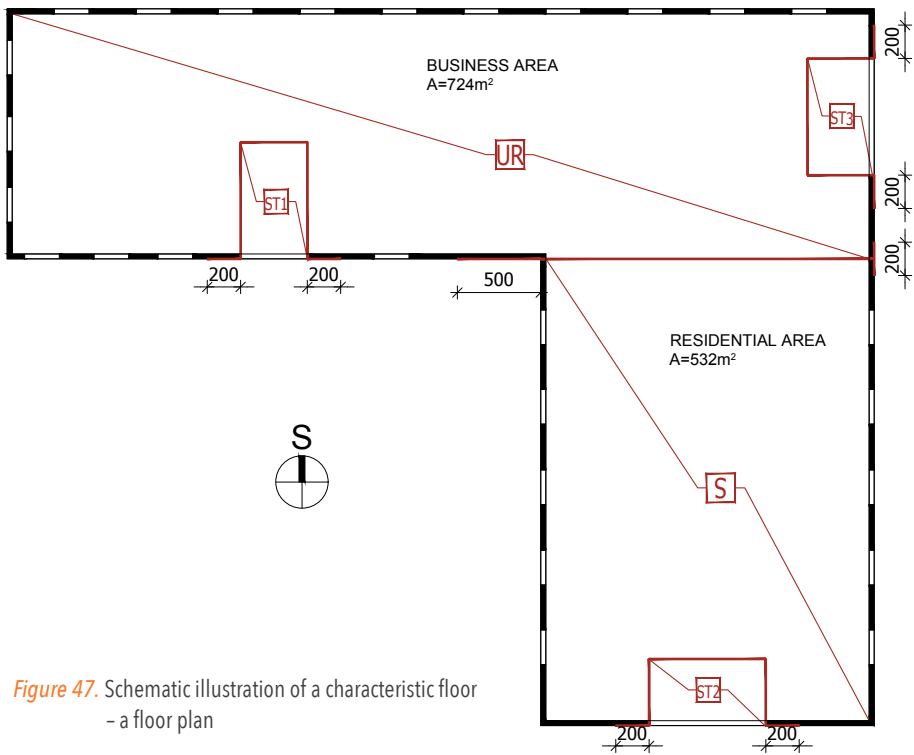

Figure 47. Schematic illustration of a characteristic floor - a floor plan

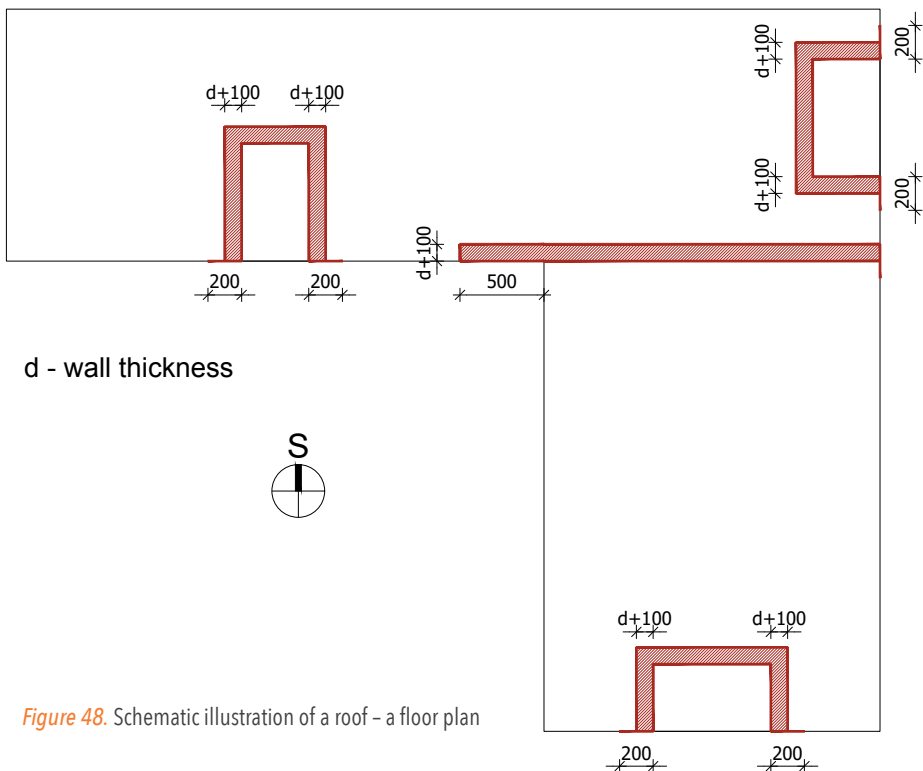

Figure 48. Schematic illustration of a roof - a floor plan

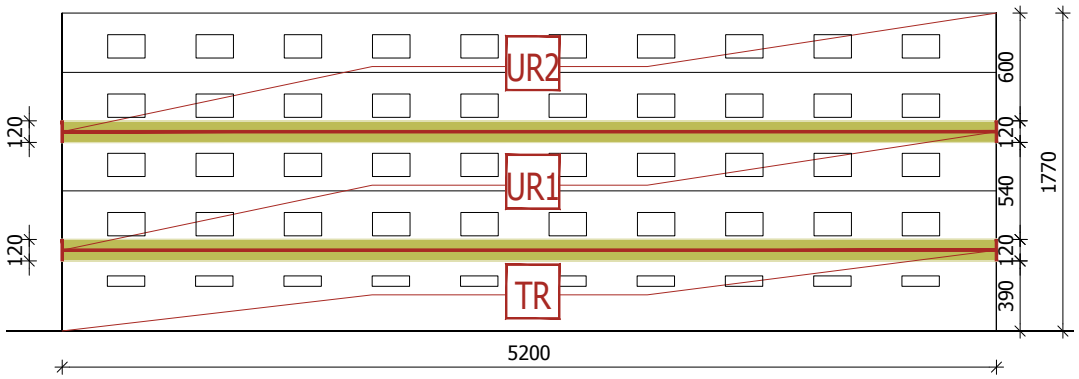

Figure 49. Schematic illustration of a north façade (view)

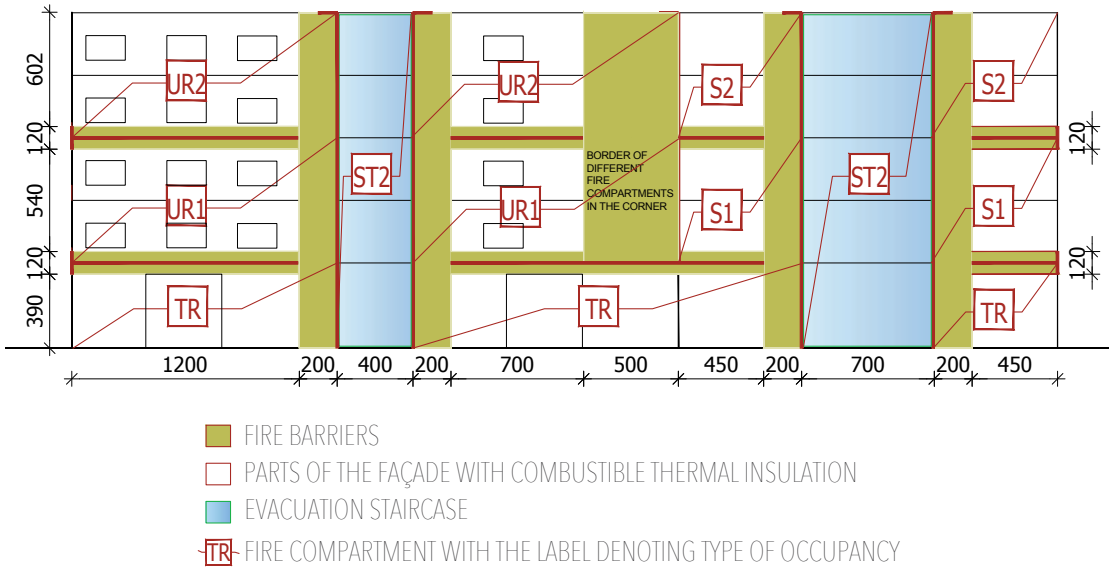

Figure 50. Schematic illustration of a south façade (view)

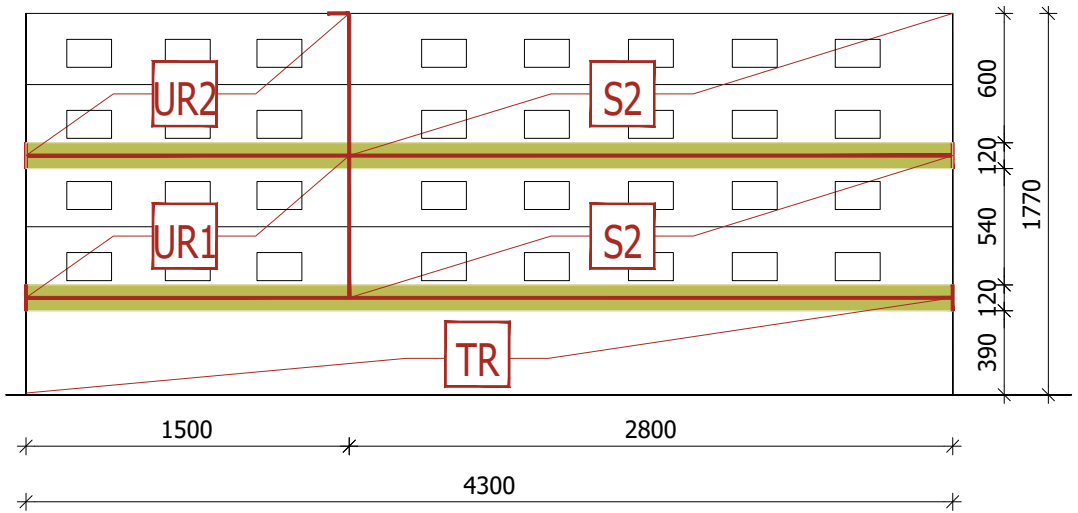
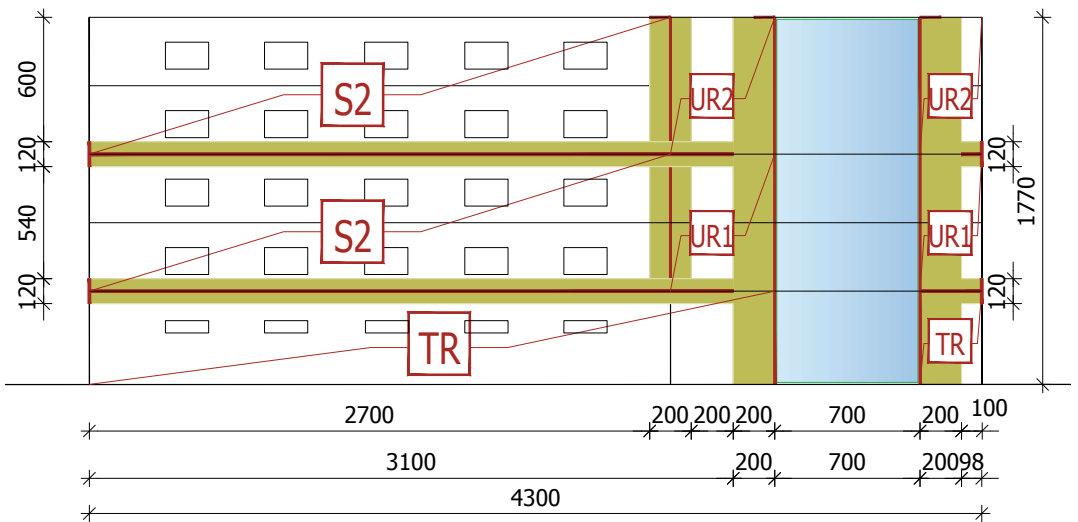

Figure 51. Schematic illustration of a west façade (view)



- FIRE BARRIERS
- PARTS OF THE FAÇADE WITH COMBUSTIBLE THERMAL INSULATION
- EVACUATION STAIRCASE
- FIRE COMPARTMENT WITH THE LABEL DENOTING TYPE OF OCCUPANCY

Figure 52. Schematic illustration of an east façade (view)

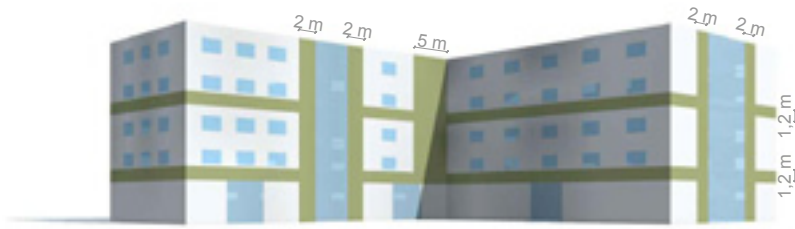

Figure 53. 3D schematic view of a southwest façade

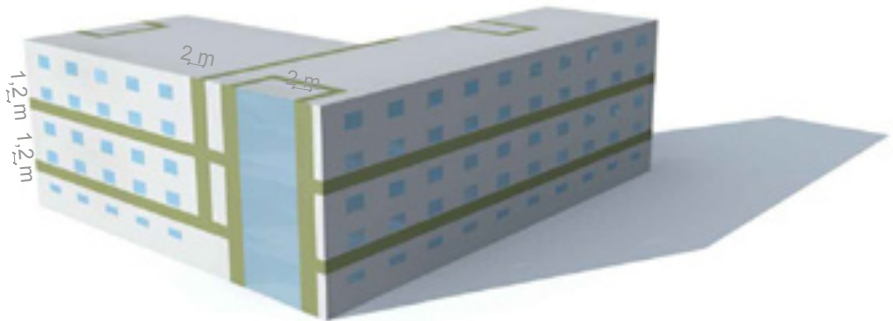

Figure 54. 3D schematic view of a northeast façade

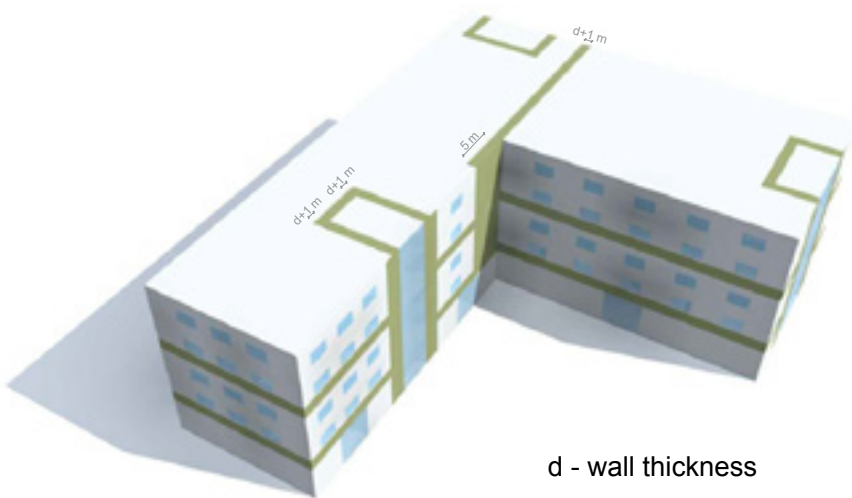

Figure 55. 3D schematic view of the roof and a southwest façade

6.3 Ventilated façades

Protection from fire spread across ventilated façades is a complex issue because there is no generally accepted prevention principle of fire spread which can be applied to all systems of ventilated façades, as is the case with contact façade systems outlined in the previous chapters. Namely, the requirement for natural ventilation and the requirement for fire prevention in the ventilated layer are contradictory [31]. The protection is achieved by installing fire barriers, that is, in this case, system components which will limit the fire spread through the ventilation space by separations or by reducing the free cross-section.

Figure 56 shows the schematic illustration of these barriers.

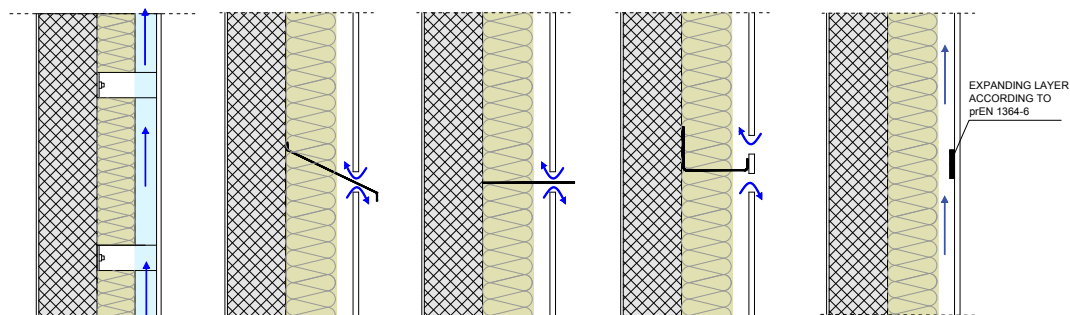

Figure 56. Execution principles of barriers on ventilated façade systems

Also, one of the methods is to install an expanding element which multiplies its volume in case of fire and closes the gap in the ventilating layer. As the proof of properties of this system European standard prEN1364-6:2016 [32] is applied which is in the process of adoption. Anyway, when executing the barriers on ventilated façades the manufacturers' instructions should be followed and they must provide the proof of the quality of such systems.

The practice has shown that the only possible way of proving the efficiency of barriers for the prevention of fire spread across such complex systems is to conduct large scale tests of façades which is not acknowledged by current Croatian legislation.

7 PROBLEMS NOT COVERED BY THE ORDINANCE AND RECOMMENDATIONS FOR THEIR SOLUTIONS

Since the provisions of the Ordinance have been in force since August 2015, their application in practice has shown that some provisions should be amended. Therefore, the authors strongly advise that the following recommendations are considered when the Ordinance is amended.

7.1 Energy renovation of old buildings lacking a fire protection report

Numerous buildings in the Republic of Croatia do not have a fire protection report because they were built at the time when it was not required or because they have undergone significant changes during use. Thus, it is difficult to include these buildings in energy renovation projects and they do not meet the requirements set out by the Ordinance. For this reason the authors suggest that for such buildings, which are usually considered as one fire compartment, a provision of the Ordinance regarding the subgroup ZP54 (Article 15, paragraph 3, the Ordinance, Figure 32 in the Guidelines) is applied, which prescribes the execution of a fire barriers from non-combustible insulation with reaction to fire class A1 or A2-s1, d0 (Article 15, paragraph 4, the Ordinance, Figure 33 in the Guidelines).

In addition, in the buildings belonging to subgroup ZPS5, where immobile or partly mobile persons reside, namely persons that cannot be independently evacuated (hospitals, retirement homes, psychiatric institutions, nurseries, nursery schools, schools etc.), and which are considered to be one fire compartment, the authors suggest that façades with non-combustible insulation are installed. Even more because the designs for energy renovation do not go through the procedure of obtaining building permits and thus are not controlled by authorised fire protection inspections.

7.2 Ventilated façades

The classified systems with combustible insulation from E to B-d1 are allowed to be used on suspended ventilated facades applied on the buildings that belong to subgroups ZPS1 and ZPS5 (see Table 4 in the Ordinance or Table 3 of this Guidelines). The authors are of opinion that, due to the described problem of fire spread across the cavities in ventilated façades (Chapters 4 and 6.3, Figure 56), and the systems which are generally not tested, ventilated façades executed in buildings belonging to subgroup ZPS4 and ZPS5, should be executed only with non-combustible insulation of reaction to fire class A1 or A2-s1, d0.

7.3 Execution of fire barriers in buildings belonging to subgroups ZPS1-ZPS3 and ZPS5

The authors' view is that the requirement for the execution of fire barriers (reaction to fire class A1 or A2-s1, d0) should be also applied on the multi-floor (G+2) buildings belonging to subgroup ZPS1 and ZPS3 if their façades contain the combustible insulation.

Also, the Ordinance should include the obligation to install non-combustible barriers for protection of the openings in buildings belonging to subgroup ZPS5 because in these buildings a number of floors can vertically be connected into one fire compartment, and there are also old buildings which are usually one fire compartment.

7.4 Non-combustible bands at joints between buildings with different height

The Ordinance deals with the issue of non-combustible bands explicitly in case of horizontal and vertical fire spread from floor to floor, but not in case of joints of different height buildings which are also different fire compartments (Figure 28). The authors suggest that the Ordinance should explicitly state that, in case of combustible thermal insulation, fire barriers at joints of higher and lower buildings be covered with non-combustible insulation (reaction to fire class A1 or A2-s1, d0) of the required length.

7.5 Cladding of firewall endings

The Ordinance neither explicitly states the requirements for cladding of firewall endings on roofs (when firewalls protrude above the roof 30 to 50 cm or finish in a cantilever), nor the firewalls protruding 50 cm above the façade, for preventing horizontal fire spread. The definition of a firewall clearly states that it should be non-combustible insulation (reaction to fire class A1 or A2-s1, d0). However, cases thereof are not clearly defined or graphically illustrated (as in Figure 30 b of these Guidelines).

7.6 Splashing zones or wet zones on façades

The Ordinance does not deal with the installation of insulation materials in so called splashing zones or wet zones when non-combustible thermal insulation is mandatory (reaction to fire class A1 or A2-s1, d0). Since these materials are not suitable for sprinkling zones due to their water absorption properties, the Ordinance should allow the application of usual materials for this purpose with good water absorption properties which mostly belong to the group of combustible materials in reaction to fire class D and E. Another possibility for execution of façades set out by the Ordinance, which is the use of classified systems with combustible insulation of class B-d1, does not impact splashing zones because the classified systems of class B-d1 cannot be used in these zones, but combustible insulation, tested as individual components, is used and it does not appear in this reaction to fire class, but in classes D and E. It is suggested that the Ordinance allows the application of such materials in sprinkling zone up to the height 60 cm above ground (Figure 57 b) because other solutions are neither justified from the point of fire protection, nor from the point of accepted technical practice.

It is the same with the positioning the insulation between non-combustible layers, for example, reinforced concrete slabs and soil layers – passable and impassable green roofs etc. (Figure 57 b), when the installation of non-combustible insulation between two non-combustible layers is not justified since any thermal insulation in this position cannot come into contact with flames and thus cannot contribute to fire at all. Also, the use of reaction to fire class B materials, allowed by the Ordinance, does not have any practical significance since the usual materials used in the world for this purpose have been tested as individual components and do not achieve this reaction to fire class, which is not necessary considering that non-combustible layers prevent contact with flames.

Within this issue it is proposed that the Ordinance considers the question of coated steel insulation panels since the insulation layers are also protected from the direct contact with fire.

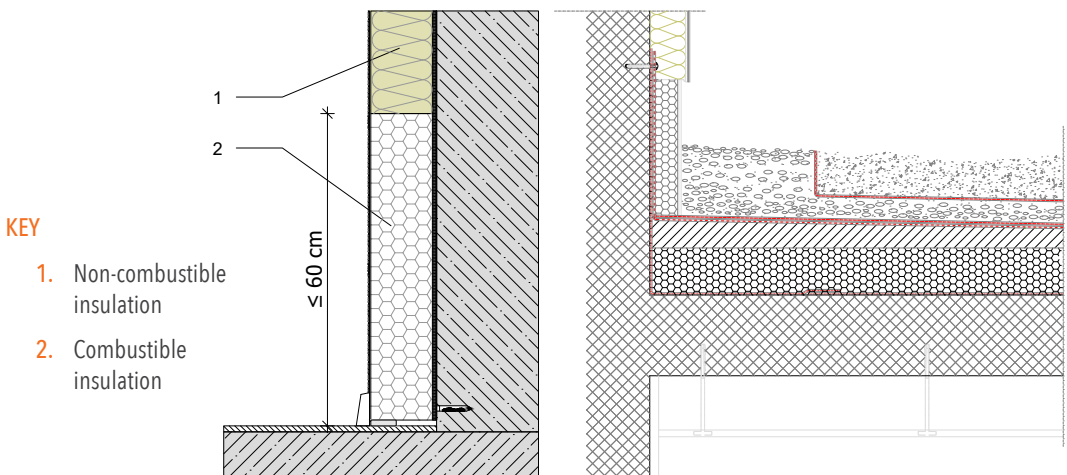

Figure 57. Details of insulation in a) splashing zone [29] b) on passable and impassable roofs

7.7 Passages, soffits and prominent parts of buildings

The authors recommend that non-combustible materials (reaction to fire class A1 or A2-s1, d0) be used for soffits of passages, balconies and loggias to prevent fire spread onto building parts above them (Figures 58 and 59), as well as for walls and ceilings of fire access routes (Figure 60).

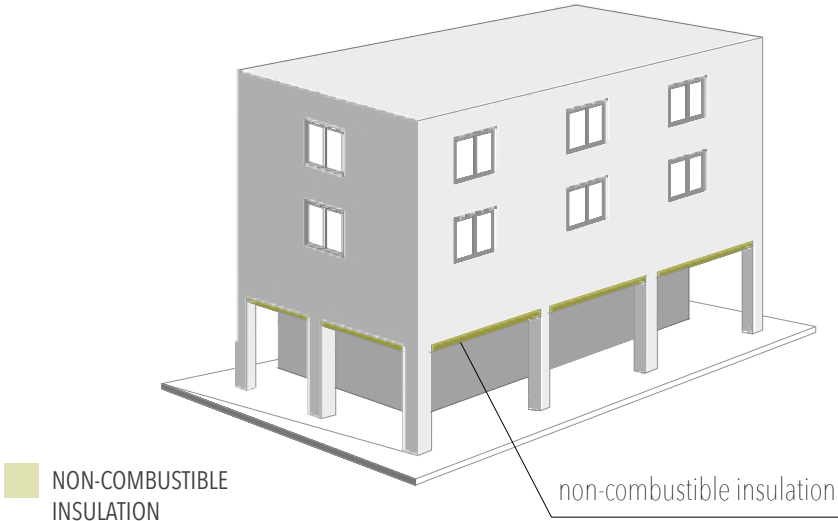

Figure 58. Soffit covered with a non-combustible material [29]

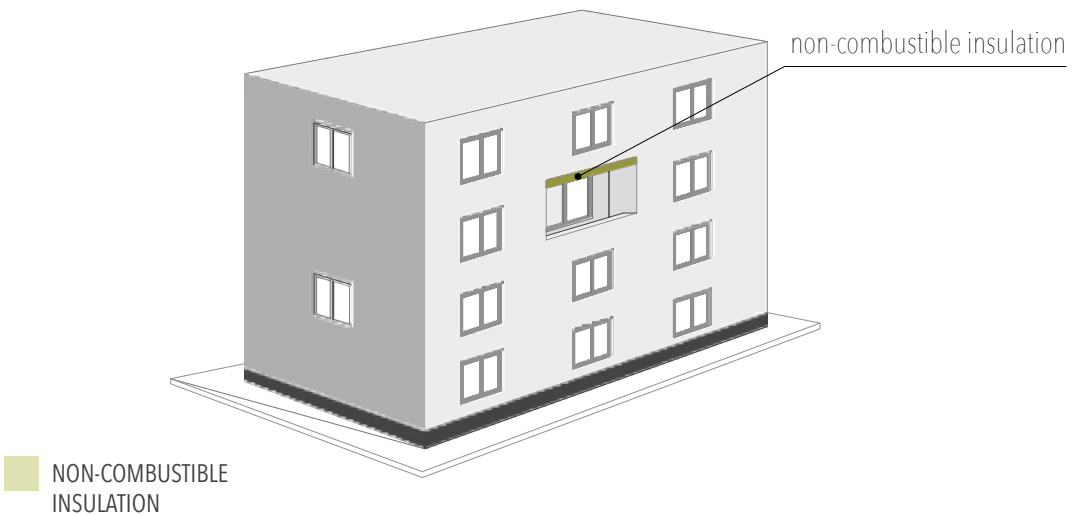
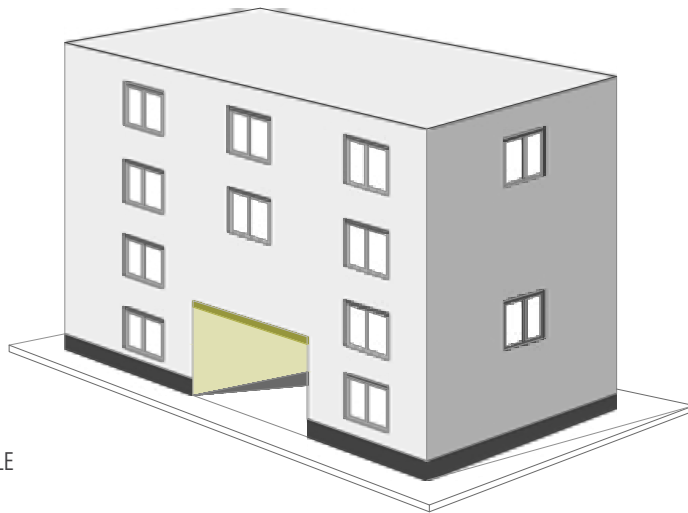

Figure 59. Loggia soffit covered with a non-combustible material [29]



■ NON-COMBUSTIBLE INSULATION

Figure 60 Fire access route through the building covered with non-combustible material [29]

7.8 External evacuation stairs

The Ordinance does not define the dimension of the parts of façades which must have non-combustible insulation (reaction to fire class A1 or A2-s1, d0) in case of external evacuation stairs, as is customary in foreign legislations. Therefore, the authors suggest that the provision is added to the Ordinance stipulating the execution of façades with the materials of reaction to fire class A1 or A2-s1, d0 in the width of more than 3 meters from each side of the end of the evacuation stairs.

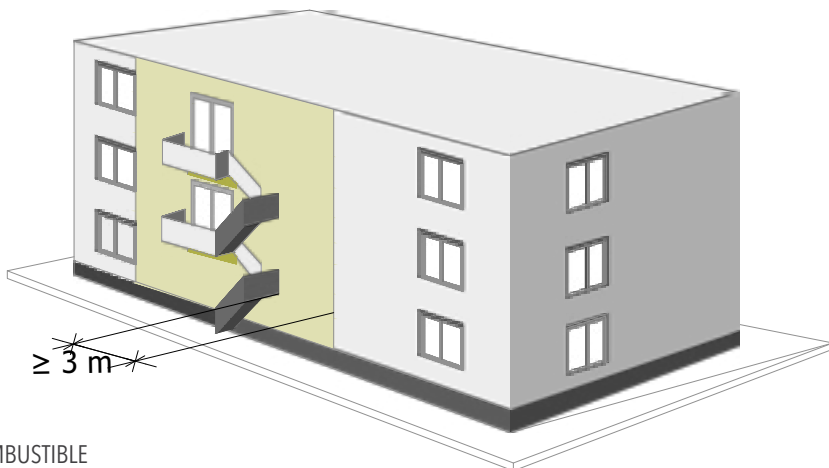

■ NON-COMBUSTIBLE INSULATION

Figure 61 External evacuation stairs with non-combustible material [29]

7.9 Request for an unambiguous definition of design level elaborating the details of façade fire protection

The concept of fire protection described in a fire protection report offers a certain number of data which should be elaborated through different design levels, which is not the accepted practice, both among designers and among the representatives of authorized inspections. It is often disputed at which level the design should present the solutions required by fire safety reports, and it is not rare practice that the solutions to the details in the fire safety reports, which by definition is not a design, are required so it cannot elaborate design solutions. This is becoming increasingly usual with regards to façade fire protection, since it is a relatively new issue required by relevant legislation. In practice, the details regarding façades are mostly not elaborated at the level of the main design, but are transferred to the level of the executive design, which means that they have not been approved by competent bodies, which only approve main designs. Increasingly, designers, and sometimes also authorised inspections, require that in cases where combustible insulation is used fire safety reports contain drawings of façades where layers of non-combustible insulation are clearly defined. However, the everyday practice does not comply with the legislation in power.

The Ordinance on the Content of Fire Safety Reports (Official Gazette 51/12) stipulates that the study gives the requirements and limitations for systematic fire protection of buildings, and pursuant to Article 69 of the Building Act (Official Gazette 153/13 and 20/17) these requirements must also be contained in the main design, which includes its elaboration at the level of the main design thereof. The above relates also to the details of façade fire protection. Although the provision seems clear, the authors suggest that this procedure is introduced into everyday practice, so that upon the review of the main design, the solutions could be authorised by the competent inspections. Thus, the problem of newly designed buildings would be solved, but the issue of energy renovation of old buildings still remains, which do not require a building permit, set out in more detail in Chapter 7.1, for which the authorised bodies should find relevant solutions so that there are no two solutions for the same problem, of which one is good and another is bad. It ultimately means that, in case of fire, there are two different levels of safety for users of new and old buildings.

8 QUOTED LEGISLATION AND REFERENCE LITERATURE:

Building Act (Official Gazette 153/15, 20/17)

Fire Protection Act (Official Gazette 92/10)

Ordinance on Fire Resistance and other Requirements for Buildings in Case of Fire (Official Gazette 29/13, 87/15)

Ordinance on Building Classification according to the Level of Fire Protection (Official Gazette 56/12)

Ordinance on the Content of Fire Protection Report (Official Gazette 51/12)

Reference:

- [1] Commission Green Paper of 8 March 2006: A European strategy for sustainable, competitive and secure energy, COM (2006) 105 final.
- [2] Communication from the Commission of 19 October 2006 entitled: Action Plan for Energy Efficiency: Realising the Potential, COM (2006) 545.
- [3] Communication from the Commission Europe 2020 A strategy for smart, sustainable and inclusive growth Brussels, 3.3.2010 COM (2010) 2020.
- [4] Communication from the Commission to the European Parliament, the Council, the Economic and Social Committee and the Committee of the Regions - Energy efficiency plan 2011 COM (2011) 109 final of 8.3.2011.
- [5] Ž. Tomšić, Legal framework for energy management and energy efficiency in the European Union; Goals of EU energy policies and energy efficiency in the European Union, 2014
- [6] Communication from the Commission to the European Parliament and the Council: The Roadmap from Paris: assessing the implications of the Paris Agreement and accompanying the proposal for a Council decision on the signing, on behalf of the European Union.
- [7] Communication from the Commission to the European Parliament, the Council, the European economic and social committee and the committee of the regions, Roadmap for moving to a competitive low carbon economy in 2050, COM (2011) 112 final, Brussels, 8th March.
- [8] 2030 Climate and Energy Policy Framework, European Council, 23th-24th October 2014.
- [9] EUROSTAT, 2013 (online dana code: nrg_100a), Consumption of energy, Pristupljeno podacima:10.3.2016.
- [10] S. Baker, T. Colwell, *Fire Performance of external thermal insulation for walls of multistorey buildings - Third Edition. 2013.*
- [11] <http://www.telegram.hr/politika-kriminal/u-studentskom-domu-cvjetno-naselje-doslo-je-do-pozara-vatrogasci-trenutne-gase-vatru/> [web page accessed: 27.3.2017.]. In student dormitory Cvjetno naselje fire broke out and firemen are extinguishing fire.
- [12] K. Kordina, C. Meyer-Ottens, *Holz Brandschutz Handbuch*. Deutsche Gesellschaft für Holzforschung e.V. (Hrsg.): Ernst & Sohn Verlag, 1995.
- [13] J. Mayr, L. Battran, *Handbuch Brandschutzatlas Grundlagen – Planung – Ausführung*. FeuerTrutz, 2014.
- [14] K. L. T. Jamison, D. A. Boardman, A new fire performance test for cavity wall insulation, *MATEC Web Conf.*, vol. 46, pp. 1–12, 2016.
- [15] I. Kotthoff, Fire performance of external thermal insulation composite systems (ETICS) in buildings, 4th Global insulation conference, 2. – 3. 11.2009. in Prague.
- [16] BS 8414-1:2002 Fire performance of external cladding systems. Test methods for non – loadbearing external

cladding systems applied to the face of building.

- [17] SP FIRE 105: External wall assemblies and façade claddings reaction to fire. Borås, Sweden.: Swedish National Testing and Research Institute SP Fire Technology; 1994.
- [18] MSZ 14800-6 Fire resistance tests. Part 6: Fire propagation test for building façades. 2009. Hungarian Standardisation Institute. (2009).
- [19] M. Hajpal, Analysis of fire cases in panel buildings in Hungary, in *Fire Brigade Reports and investigations*, April, 2013, pp. 96–108.
- [20] <http://www.bbc.com/news/world-europe-11752303>
[web page accessed: 27.3.2017.]
- [21] L. Peng, Z. Ni, X. Huang, Review on the fire safety of exterior wall claddings in high-rise buildings in China, *Procedia Eng.*, vol. 62, pp. 663–670, 2013.
- [22] https://en.wikipedia.org/wiki/Beijing_Television_Cultural_Center_fire#/media/File:TVCC_Site_2007.jpg
[web page accessed: 27.3.2017.]
- [23] http://www.nbcnews.com/id/29099358/ns/world_news-asia_pacific/t/china-tv-sorry-fireworks-caused-bla-ze/#.WN0Z-7gIGUk
[web page accessed: 27.3.2017.]
- [24] https://ko.wikipedia.org/wiki/CCTV_%ED%85%94%EB%A0%88%EB%B9%84%EC%A0%84_%EB%A-C%B8%ED%99%94_%EC%84%BC%ED%84%B0_%ED%99%94%EC%9E%AC#/media/File:CCTV_new_headquarters_Fire_20090209.jpg
[web page accessed: 26.3.2017].
- [25] <http://www.sesvete-danas.hr/hrvatska-i-svijet/zagreb/pozar-u-studentskom-domu-cvjetno-naselje-1196>
[web page accessed: 30.3.2017.]. Fire in student dormitory.
- [26] National Fire Protection Association, 2015 NFPA 101: Life Safety Code.
- [27] Österreichisches Institut für Bautechnik, OIB-Richtlinie 2: Brandschutz.
- [28] Interpretative Document, Essential Requirement No2“Safety in case of fire” OJ EC, No C 62/23, 1994.
- [29] Fachverband Wärmedämm-Verbundsysteme e.V, Technische Systeminfo 6 WDV-Systeme zum Thema Brandschutz, 2014.
- [30] Protection contre l' incendie des façades béton ou maçonnerie revêtues de systèmes d' isolation thermique extérieure par enduit sur polystyrène expansé (ETICS-PSE).2016.
- [31] G. Jensen, Fire spread modes and performance of fire stops in vented façade constructions – overview and standardization of test methods,” 1St Int. Semin. *Fires Saf. Facades*, vol. 2002, 2013.
- [32] prEN 1364-6 Fire Resistance Tests For Non-Loadbearing Elements Part 6: Cavity Barriers.
- [33] HUPFAS Croatian Association of Facade Thermal Insulation Systems (HUPFAS), Guidelines for ETICS systems, 2016.
- [34] D. Bjegović, I. Banjad Pečur, B. Milovanović, M. Jelčić Rukavina, M. Alagušić, Comparative full-scale fire performance testing of ETICS systems, *Gradevinar*, vol. 68, no. 5, pp. 357–369, 2016. doi: <https://doi.org/10.14256/JCE.1347.2015>
- [35] DIN 4102-20:2016-03 – Draft Fire behaviour of building materials and building components - Part 20: Particular verification of the fire behavior of cladding for external walls.

ANNEX 1: Classification of construction materials according to reaction to fire properties

With regards to behavior of materials in fire, the Republic of Croatia has accepted EN standards, but until 2019 previously used DIN standards can be applied. The European standard for classification of building products to their reaction to fire properties (HRN EN 13501-1:2010) classifies materials into seven classes (A1, A2, B, C, D, E and F, Table 4), three additional classes regarding smoke production (s1, s2 and s3, Table 5) and three additional classes regarding formation of flaming droplets/particles (d0, d1 and d2, Table 6).

Combinations of above classes give a total of 40 different classes of materials which define the reaction of materials in fire (Table 7).

Table 4. Euroclasses of reaction to fire [HRN EN 13501-1:2010]

| Euroclass | Behavior of material |
|----------------|---|
| A ₁ | Non-combustible material/product |
| A ₂ | |
| B | Material/product of limited combustibility |
| C | Combusts within 10 to 20 min |
| D | Combusts within 2 to 10 min |
| E | Combusts within 2 min |
| F | Products/materials without the classification of reaction to fire or products/materials which do not meet the requirements for classes A1, A2, B, C, D or E. As a rule, easily combustible materials. |

Table 5. Additional classification according to smoke production

| | |
|----|---|
| S1 | A small quantity of smoke allowed |
| S2 | Limited production of smoke but the increased quantity of smoke |
| S3 | Quantity of smoke not limited |

Table 6 Additional classifications according to flaming droplets/particles

| | |
|----|--|
| d0 | Flaming droplets/particles not allowed |
| d1 | Limited quantity of flaming droplets/particles |
| d2 | Quantity of flaming droplets/particles not limited |

Table 7. Combinations of reaction to fire classes of building materials

| | | |
|----------|----------|----------|
| A1 | | |
| A2-s1,d0 | A2-s1,d1 | A2-s1,d2 |
| A2-s2,d0 | A2-s2,d1 | A2-s2,d2 |
| A2-s3,d0 | A2-s3,d1 | A2-s3,d2 |
| | | |
| B-s1,d0 | B-s1,d1 | B-s1,d2 |
| B-s2,d0 | B-s2,d1 | B-s2,d2 |
| B-s3,d0 | B-s3,d1 | B-s3,d2 |
| | | |
| C-s1,d0 | C-s1,d1 | C-s1,d2 |
| C-s2,d0 | C-s2,d1 | C-s2,d2 |
| C-s3,d0 | C-s3,d1 | C-s3,d2 |
| | | |
| D-s1,d0 | D-s1,d1 | D-s1,d2 |
| D-s2,d0 | D-s2,d1 | D-s2,d2 |
| D-s3,d0 | D-s3,d1 | D-s3,d2 |
| | | |
| E | | |
| E-d2 | | |
| F | | |

Reaction to fire classification of building products is carried out according to the results of the tests stated in Table 8, within a simulated fire situations (according to the phases of fire development) on small scale specimens.

Table 8. Testing methods for classification of materials according to the reaction to fire property

| Class | Testing standard | Testing type |
|-------|--|---|
| A1 | HRN EN ISO 1182 and HRN EN ISO 1716 | Testing non-combustibility and thermal potential |
| A2 | HRN EN ISO 1182 or HRN EN ISO 1716 and HRN EN 13823 | Testing non-combustibility and thermal potential and testing with single burning item (SBI) |
| B | HRN EN 13823 and HRN EN ISO 11925-2 | SBI testing and testing with single flame source |
| C | HRN EN 13823 and HRN EN ISO 11925-2 | SBI testing and testing with single flame source |
| D | HRN EN 13823 and HRN EN ISO 11925-2 | SBI testing and testing with single flame source |
| E | HRN EN ISO 11925-2 | Testing with single flame source |
| F | Behavior not determined | Testing is not conducted |

The full names of the above standards is as follows:

- | **HRN EN 13501-1:2010** Fire classification of construction products and building elements -- Part 1: Classification using data from reaction to fire tests,
- | **HRN EN ISO 1182:2010** Reaction to fire tests for products -- Non-combustibility test,
- | **HRN EN ISO 1716:2011** Reaction to fire tests for products -- Determination of the gross heat of combustion (calorific value),
- | **HRN EN 13823:2015** Reaction to fire tests for building products -- Building products excluding floorings exposed to the thermal attack by a single burning item,
- | **HRN EN ISO 11925-2:2011** Reaction to fire tests -- Ignitability of products subjected to direct impingement of flame -- Part 2: Single-flame source test

In accordance with the above classification of reaction to fire, pursuant to the Guidelines by the Association of the producers of thermal façade systems [33], classified ETICS systems available on the Croatian market are shown in Table 9.

Table 9. Reaction to fire classification of ETICS systems available on the Croatian market [33].

| ETICS SYSTEM TYPE | Reaction to fire class according to HRN EN 13501-1 |
|--|--|
| ETICS-EPS with mineral finishing plaster | B-s1, d0 |
| ETICS-EPS with organic finishing plaster | B-s1/s2, d0 |
| ETICS-MW with mineral finishing plaster | A2-s1, d0 |
| ETICS-MW with organic finishing plaster | A2-s1/s2, d0 |

Compared to the combustibility classification according to HRN DIN 4102-1 used so far (that is, classification into a combustible, hardly combustible, normally combustible and easily combustible material), there is no simple description for each reaction to fire class and neither the above classes can be directly translated into particular combustibility class. Still, properties of material behaviour according to both classifications can be linked according to Table 10.

Table 10 Comparative view of reaction to fire classes (HRN EN) with the combustibility classification (HRN DIN)

| | Additional requirements | | HRN EN 13501-1 | HRN EN 4102-1 | | |
|----------------------|-------------------------|-------------------------------|-------------------|------------------|---|----------|
| | Smoke is not developed | No flaming droplets/particles | | | | |
| NON-COMBUSTIBLE | x | x | A1 | A1 | | |
| | x | x | A2-s1,d0 | A2 | | |
| HARDLY COMBUSTIBLE | x | x | B-s1,d0 | B1 | | |
| | | | C-s1,d0 | | | |
| | x | x | A2-s2,d0 | | | |
| | | | A2-s3,d0 | | | |
| | | | B-s2,d0 | | | |
| | | | B-s3,d0 | | | |
| | | | C-s2,d0 | | | |
| | | | C-s3,d0 | | | |
| | | | x | | x | A2-s1,d1 |
| | | | | | | A2-s1,d2 |
| | B-s1,d1 | | | | | |
| | B-s1,d2 | | | | | |
| | C-s1,d1 | | | | | |
| | C-s1,d2 | | | | | |
| x | x | A2-s3,d2 | | | | |
| | | B-s3,d2 | | | | |
| | | C-s3,d2 | | | | |
| NORMALLY COMBUSTIBLE | x | x | D-s1,d0 | B2 | | |
| | | | D-s2,d0 | | | |
| | | | D-s3,d0 | | | |
| | | | E | | | |
| | x | x | D-s1,d1 | | | |
| | | | D-s2,d1 | | | |
| | | | D-s3,d1 | | | |
| | | | D-s1,d2 | | | |
| | | | D-s2,d2 | | | |
| | | | D-s3,d2 | | | |
| | x | x | E-d2 | | | |
| EASILY COMBUSTIBLE | | | F | B3 | | |

ANNEX 2: Large scale testing of façade behaviour in fire

Encouraged by the issue of fire which has become more evident due to the massive inadequate energy renovation of buildings in EU, including Croatia, the Faculty of Civil Engineering, the University of Zagreb, the European association Fire Safe Europe (FSEU) and Croatian Fire Protection Association (HUZOP) held a scientific-professional international seminar "Facades in Fire". The organisers conducted a public testing of behaviour of facades under the impact of fire, with the aim to show that façades can considerably influence the fire spread over the building and that the reaction to fire testing of materials on façades systems is inadequate, that is, with the aim to express the necessity to conduct a large scale testing of façade behaviour. A public testing was conducted in the Laboratory for Thermal Measurements (LTM) in Stubička Slatina. Apart from LTM, two other prominent scientific partners conducted measurements: SP (Technical Research Institute of Sweden) and ZAG (Construction Institute, Slovenia). Testing was conducted according to the British standard BS 8414-1:2002 [16] simultaneously on three test samples with a different layer of thermal insulation according to Table 11 [34].

Table 11 Description of façade specimens

| Specimen label | Thermal insulation material and its thickness | Plaster type | Fixing method of thermal insulation | Reaction to fire classification |
|----------------|--|--|-------------------------------------|---------------------------------|
| Specimen 1 | Expanded polystyrene (EPS) - 150 mm | Mortar reinforced with glass mesh and finishing organic (acrylic) plaster - 5 mm | Glued and mechanically fixed | B-s2, d0 |
| Specimen 2 | Expanded polystyrene (EPS) - 150 mm + fire barrier 150 mm thick and 200 mm directly above the combustion chamber opening | | | B-s2, d0 (A2-s1, d0 barrier) |
| Specimen 3 | Stone mineral wool - 150 mm | | | A2-s1, d0 |

The time sequence of behaviour of each façade specimen during testing is shown in Figure 62. The main conclusion of testing is that non-combustible fire barriers (that is, the ones made of stone mineral wool) can, even at a relatively small height of only 20 cm above the opening, considerably slow down the fire spread and the vertical temperature increase across the façade. According to SBI (single burning item) testing, ETICS systems with EPS have a reaction to fire class B-s2, d0, which means the absence of flaming droplets. This fact confirms the theory that SBI testing (namely, testing according to the reaction to fire properties) is not suitable for systems which will, when applied, be considerably higher compared to the ones required by SBI testing, which is the category façades definitely belong to.

As previously stated, in some European countries (e.g. Sweden, UK, Germany, Hungary etc.) large scale testing and assessment of façades with regards to their behaviour in fire is conducted. Due to the difference in testing methods thereof, e.g. in sample size, in the parameters being observed and test result assessment, it has been necessary to harmonise European norms on testing façades in fire. The project of assessing such standard is on-going under the title **Development of a European approach to assess the fire performance of façades**, whereby the new standard will be based on two existing standards BS 8414-1 :2002 [16] and DIN 4102-20:2016 [35]. A new standard and assessment criteria will definitely contribute to the more realistic assessment of façade behavior in fire regarding the existing reaction to fire classification, since, apart from the recommendations stated in Chapter 7, the improvement of the existing Ordinance can be noticed.





| | |
|--|---|
|  | <p>The façade systems from left to right: Specimen 1 classified system B-s2, d0, with combustible insulation (EPS), Specimen 2 is a classified system B-se, d0 with combustible insulation (EPS) + 20 cm of horizontal fire barrier made of stone wool, Specimen 3 is a classified system A2-s1, d0, made of non-combustible insulation (stone wool). All other components are identical in all three specimens. The photo shows the very beginning of the test (00:30) when the combustion chambers, simulating a fire in an apartment, were ignited.</p> |
|  | <p><u>15 minutes after the start of fire:</u> Specimen 1 is completely caught by fire and a large amount of toxic smoke and gases is emitted. Flaming droplets of burning insulation fall on the floor and increase the area affected by fire. At this point there is no significant difference between the reaction of specimen 2 and specimen 3.</p> |
|  | <p><u>19 minutes after the start of fire:</u> Specimen 1 is still emitting a large amount of toxic smoke and gases. On Specimen 2 the fire has skipped the horizontal fire barrier above the window and caught the combustible insulation (EPS) which is indicated by the black smoke on the top of the wall. On Specimen 3 the insulation has not caught fire.</p> |
|  | <p><u>28 minutes after the start of fire:</u> Specimen 1 has burnt out, the fire in the furnace is still burning. The metal frame with sensors has prevented the falling of the finishing decorative layer (plaster). On Specimen 2 the fire has completely caught the combustible insulation. On Specimen 3 there is not any visible changes compared to previous stage.</p> |
|  | <p><u>40 minutes after the start of fire:</u> Specimen 2 is still burning and emitting toxic smoke, although the fire is not visible. The horizontal fire barrier above the opening has delayed the fire spread for 10 minutes, but also extended the time of burning of the insulation and emission of toxic gases. The fire in the combustion chamber on Specimen 3 was extinguished by itself. Unlike Specimen 1 and Specimen 2, the façade on Specimen 3 has not been structurally destroyed.</p> |

Figure 62. The course of behaviour testing of different façade systems

The University of Zagreb, The Faculty of Civil Engineering, Zagreb, Croatia, 2017

All rights reserved; no part of this publication may be reproduced, stored in a retrieval system, or transmitted in any form or by any means, without the prior written permission of the Publisher.

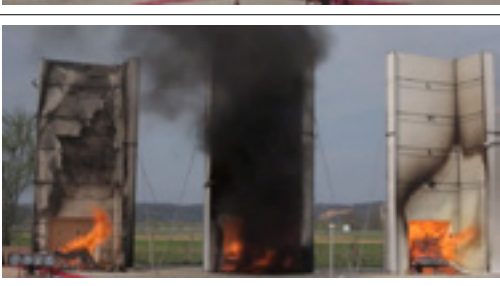
Photograph on the cover: The fire on Cvjetno naselje student home, Zagreb, February 2017. SOURCE: CROPIX